



CyClean™
CyClean™-R
RoClean™
TakClean™
TakClean Ultra™
VacClean™

Non-Contact & Contact Web Cleaning Systems Overview





Meech International: Your Global Partner

We've got the world covered

Wherever you are in the world, you'll find Meech hard at work, providing a wide range of businesses with technical expertise. From our headquarters and Technical Centre in the UK, our manufacturing subsidiary in the USA and sales offices in Belgium, Hungary, China, India and Singapore, we've got the world covered.

In fact, our distribution network now covers over 50 countries, providing easy access to fully trained and carefully selected Meech distributors, who can provide in-depth support - wherever you are based.

Outstanding quality as standard

As with every Meech system, quality is at the heart of all of our web cleaning systems. We always work to the highest possible quality standards in everything we do: manufacturing, customer support and technical know-how. Our quality management system is certified by BSI to ISO9001. Products manufactured by Meech are appropriately certified to international standards. They carry markings including CE and UL/CSA (CUL).

We also hold ATEX and UL "EX" approvals for use in hazardous environments. So, you can be sure you've chosen a solution and a company that will meet your own exacting standards.

World leaders in web cleaning and static control

No-one knows the specialist fields of web cleaning and static control better than Meech and the practical benefits can be seen at work. Unique design characteristics in each of our web cleaning systems, whether it is contact or non-contact, will help you to maximise the return on your investment.

All the experience you need

Established in 1907, Meech has earned a worldwide reputation for the design and manufacture of effective, durable systems that are supported by our knowledgeable technical team. With so much to offer, no wonder our global user list has grown to in excess of 7,000 companies including:

- 3M
- Amcor Flexibles
- Avery Dennison
- Colgate
- Edale
- Focus Label
- Hymmen
- Innovative Machine
- Mark Andy
- Nilpeter
- Olbrich
- OMET
- Precision Coating
- RockTenn
- Scapa
- SMI Coated
- Sotech
- Spartanics
- Superweb
- Webtech Labels
- Werosys
- WS Packaging
- Xeikon
- Zebra Technologies



CyClean on Mark Andy Versa Max press

Cleaning Technologies

Meech is a leading web cleaning system manufacturer with a comprehensive range of systems. Each system is based on a different cleaning principle. Uniquely, this allows us to provide our customers with a system best suited to their application.

The Meech range comprises two non-contact and two contact cleaning technologies:

■ **Non-Contact:**
CyClean and CyClean-R

■ **Contact:**
RoClean, TakClean, TakClean Ultra and VacClean

All Meech systems incorporate the latest shockless static control as standard – this is crucial for comprehensive contamination removal.



Cyclean Web Cleaner

System Selection Criteria

Meech web cleaning specialists will guide you through our range of systems, identifying the one most suitable for your application and requirements.

This discussion is best completed face-to-face at the machine, however we have prepared the following questions to help you start identifying the most suitable system:

- What is the web material and speed?
- What is the critical part of the process that is driving the need for web cleaning?
- Does the application demand non-contact cleaning now or in the future, i.e. could you change the material processed on the line?
- What is the web width?
- What type of contamination needs to be removed?
- How much space is available for the cleaning head?
- Is the web under tension and at what level?

Web cleaning systems provide effective solutions to problems such as:

- Dirty webs causing loss of profit and customer dissatisfaction
- Excessive downtime on printing presses
- Frequent blanket washing
- High reject rates in laminating or coating processes
- Unacceptable quality in pharmaceutical or food packaging
- Poor print quality
- Cleaning of battery film

System Selection by Application

The table below shows the Meech web cleaning system that is commonly used in certain, typical, web cleaning applications.

This table is not extensive, so if your application is not listed, please contact us to discuss which system is best suited.

Types of Contamination

Meech systems are used to remove many types of dry and unbonded contamination from the web surface. Some common types include:

- Die cut chads
- Dust – ambient
- Dust - slitting
- Fibres
- Hair
- Insects – mosquitoes etc

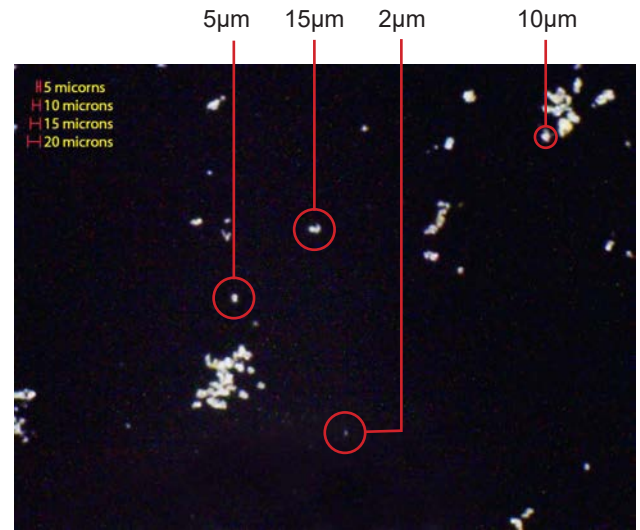

x75 magnified view of surface contamination

	CyClean & CyClean-R	RoClean	TakClean & TakClean Ultra	VacClean
Automotive	✓	✓		✓
Battery - aluminium foil	✓	✓		
Blister packs	✓	✓		
Coating	✓	✓	✓	✓
Corrugating	✓	✓		✓
Filter material	✓	✓		
Food and medical packaging	✓	✓	✓	✓
Labelling	✓	✓	✓	✓
Laminating	✓	✓	✓	
LCD screens		✓		
Optical film	✓	✓	✓	
Paper making & converting		✓		✓
Pharmaceutical	✓	✓	✓	
Printing	✓	✓	✓	✓
Slitting & winding	✓	✓		✓
Solar panel substrates	✓	✓		
Specialty films	✓	✓	✓	
Wood/furniture and flooring		✓		✓

Effective Cleaning

To achieve effective cleaning, a system must be able to perform three critical tasks:

1. Break the boundary layer
2. Neutralise static charges
3. Remove and trap contamination away from the web

If the web cleaning system fails to perform any one of the three tasks, effective cleaning will not be achieved.

Boundary Layer

A boundary layer of air is present on all moving webs. It is formed by ambient air that is dragged along by the moving web, no matter how slow or fast it is moving.

With a slow moving web, the boundary layer is thin. As the speed of the web increases, so does the thickness of the boundary layer.

Breaking the boundary layer is critical, as contamination is:

- Trapped directly on the web surface under the boundary layer
- Held within the boundary layer

If the boundary layer is not removed, it may be possible to remove some contamination from the web, but it will not be fully cleaned. Each Meech system uses a different technology to fully break through the boundary layer, ensuring excellent contamination removal.

The chart below shows the relationship of the boundary layer thickness (mm) to the web speed (m/min).

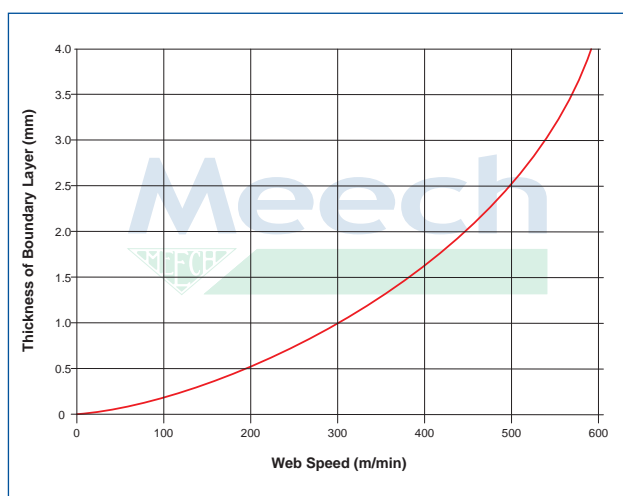

Static Neutralisation

A static charge will most likely be present on the web surface. Static charges are typically generated by either separation or friction. For example, a static charge will be generated as the web is unwound (separation), or as the web travels over non conductive nip rollers (friction).

Until neutralised, a static charge will trap and hold contamination already present on the web to its surface. It will also pull ambient airborne contamination to the web, causing further contamination. Therefore, to achieve excellent cleaning, it is vital that the static charge is removed as part of the cleaning process.

A static charge can be either positive or negative in polarity. All Meech systems incorporate powerful ionising bars that will neutralise the static charge present irrespective of the polarity.

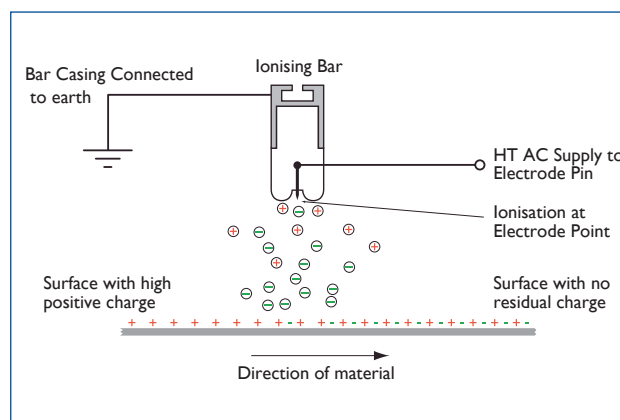

Remove and Trap Contamination

Each Meech system removes contamination from the web surface in a different way. This ensures that Meech can provide the most effective cleaning method based on the application. For example, a paper converting line requires a system that can remove high levels of typically larger sized contamination, compared to an aluminium electrode web for battery cell production that typically has fewer contaminants of a smaller size – one technology does not suit all.

The Meech CyClean, CyClean-R, RoClean and VacClean systems use the Meech Air Handling Unit (AHUv3). The AHUv3 is exclusively used in Meech systems to provide the airflows and filtration that traps the contaminants. The AHUv3 is supplied as standard with an F8 grade bag filter and can be upgraded to include a H14 grade HEPA filter (99.99% efficient at 0.3 micron).

The Meech TakClean systems includes a consumable adhesive roll that contamination is transferred to. The adhesive roll has a high adhesive mass and contaminants are trapped on the surface. Meech supplies high and low tack adhesive rolls in either perforated or continuous forms.

Meech Systems at a Glance

	Cleaning Technology	Type	Single or Double Sided Cleaning	Removes Particle Size
CyClean	Airflow Combination	Non-Contact	Double	0.5 micron
CyClean-R	Airflow Combination	Non-Contact	Single or Double	0.5 micron
RoClean	Rotary Brush & Airflow Combination	Contact	Single or Double	0.3 micron
TakClean & TakClean Ultra	Tacky Roller	Contact	Single or Double	0.5 micron
VacClean	Vacuum	Contact	Single or Double	<2 micron

CyClean Technical Specification

Maximum Web Speed	800m/min, 2624 ft/min
Maximum Web Width	2600mm (wider web systems available as special builds)
Standard Widths	100 increments up to 600mm, then 200mm increments
Static Control (active)	4 x 914 AC bars; 110/240V AC, 50/60Hz
Single or Double Sided	Double sided as standard

CyClean- R Technical Specification

Maximum Web Speed	800m/min, 2624 ft/min
Maximum Web Width	9000mm
Standard Widths	50mm increments up to 600mm, then 100mm increments
Static Control (active)	2 x 924IPS DC bars; 24V DC (21-27V DC) Max 500mA
Single or Double Sided	Single Sided and Double sided configuration available
Opening	Manual or pneumatic

RoClean Technical Specification

Maximum Web Speed	500m/min, 1640ft/min
Maximum Web Width	1010mm
Standard Widths	100mm increments
Static Control (active)	2 x 924IPS DC bars; 24V DC (21-27V DC) Max 500mA (integrated)
Single or Double Sided	Single Sided and Double sided configuration available
Webbing Up	Manual

TakClean Technical Specification

Maximum Web Speed	250m/min, 820ft/min ¹
Maximum Web Width	600mm (wider web systems available as special builds)
Standard Widths	50mm increments up to 800mm, then to application requirements
Static Control (active)	2 x 914 AC bars; 110/240V AC, 50/60Hz
Single or Double Sided	Single and double sided available
Opening (Access to elastomer and adhesive rollers)	Manual (remove the pneumatic)

1. Dynamic balancing for faster web speeds is available.

TakClean Ultra Technical Specification

Maximum Web Speed	250m/min, 820ft/min
Maximum Web Width	1450mm
Standard Widths	50mm increments up to 800mm, then to application requirements
Static Control (active)	2 x 924IPS Pulsed DC Ionising Bars
Single or Double Sided	Single and double sided available
Opening (Access to elastomer and adhesive rollers)	Manual

VacClean Technical Specification

Maximum Web Speed	1600m/min, 5249ft/min
Maximum Web Width	8000mm (wider web systems available as special builds)
Standard Widths	To application requirements
Static Control (active)	2 x 914 AC bars; 110/240V AC, 50/60Hz
Single or Double Sided	Single and double sided available
Opening	N/A



CyClean™

Non-Contact Web Cleaning

The Meech CyClean has been designed in response to increased demand for a compact, high performance, non-contact web cleaning system. Through the application of advanced computational fluid dynamics, Meech has optimised the cleaning efficiency of CyClean to remove and extract contamination to below 1 micron.

A CyClean system comprises three main components; the cleaning head, active static control and an Air Handling Unit (AHUv3).

The double-sided non-contact cleaning head has been designed to provide excellent contamination removal, whilst minimising any risk of web recontamination. On each side of the web there is a powerful blowing airflow that strips the boundary layer and contamination from the web surface. Two vacuum airflows catch all the turbulent air and contamination from within the cleaning head. Each CyClean head incorporates four shockless ionising bars; two positioned on either side of the web, one on entry to and one on exit from the head. Ionising bars ensure neutralisation of any static charges on the web that are holding contaminants to the web surface. The risk of re-attraction of contaminants to the cleaned web surfaces is also minimised.

The AHUv3 provides the airflow and filtration for CyClean.

Applications

CyClean can be used in a wide variety of applications and as it is non-contact, it can be used with all web materials.

Typical applications include:

- Printing; flexo, digital, gravure and ink jet
- Coating
- Laminating
- Food and medical packaging
- Specialty film processing
- Solar panel substrates
- Battery - aluminium foil
- Blister packs

Installation

The CyClean head unit can be installed at any angle without jeopardising cleaning performance. However, the web must be under constant tension as it passes through the CyClean head.

For easier installation, manual opening CyClean Systems feature a unique 'fixed ports' system that allows the ducting connections to remain stationary when the head unit is opened. This makes installing ductwork through a machine back plate far easier.



CyClean manual opening fixed ports system

How CyClean Works

- The web passes through a cloud of ionisation on entry to the CyClean head, which neutralises any static charges.
- The web is then subject to a force of turbulent air created by the blowing and vacuum airflows within the head unit.
- High frequency micro-movements of the web are created by the turbulent air.
- The combination of the high frequency micro-movements and turbulent air shatters the web boundary air layer, releasing the contamination into the vacuum airflows.

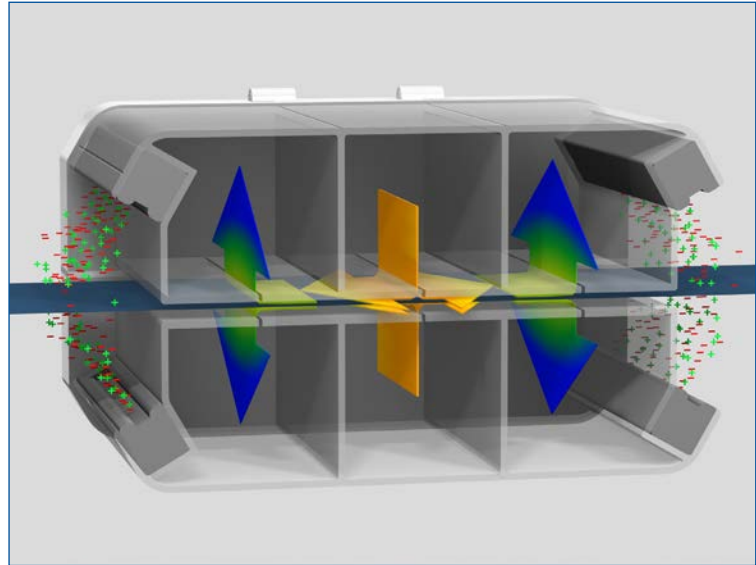

- As the web exits the CyClean head, it passes through a second cloud of ionisation to prevent re-contamination of the web.

Design Features

The CyClean is constructed from anodised aluminium. It is a highly rigid and compact system. Based on our unrivalled experience and an extensive development program, we have included several unique features in the system:

Feature	Benefit
Non-contact cleaning	Eliminates risk of surface marking and damage. No interference with web tension or web tracking.
Compact design	Flexible positioning & easy installation.
Integrated static control	Neutralises static charges to optimise cleaning performance and prevent re-contamination.
Unique 'fixed ports' system	The ducting connections to the cleaning head remain stationary, resulting in easier installation.
Air balancing	Allows complete control of the bias between blowing and vacuum airflows.
Automatic vacuum pressure control	Reduces the frequency of required operator adjustments. Maintains optimum cleaning performance automatically.
Hinged, clam shell design	Allows unit to open for easy threading of the web.
No consumable items	Lower ongoing costs.
Quiet operation	Can be installed in enclosed work areas. No H&S issues due to noise.

CyClean Head Opening Configurations

CyClean systems for web widths up to 600mm are supplied as standard in manual opening configuration. If required this can be upgraded to pneumatic opening. Systems for widths of 601mm or greater are supplied as standard with pneumatic opening. Systems to be installed on a vertical web include guided pneumatic cylinders.

"We at Webtech were looking for a web cleaning solution on our new Gidue machine, without the need for constantly changing adhesive rollers. We chose the CyClean non contact system from Meech for its robust design and excellent cleaning abilities. We are delighted with the system performance and look forward to installing more of these in the time to come. The sales and service support from their local representatives has also been a very good."

*Managing Director, **Webtech Labels***

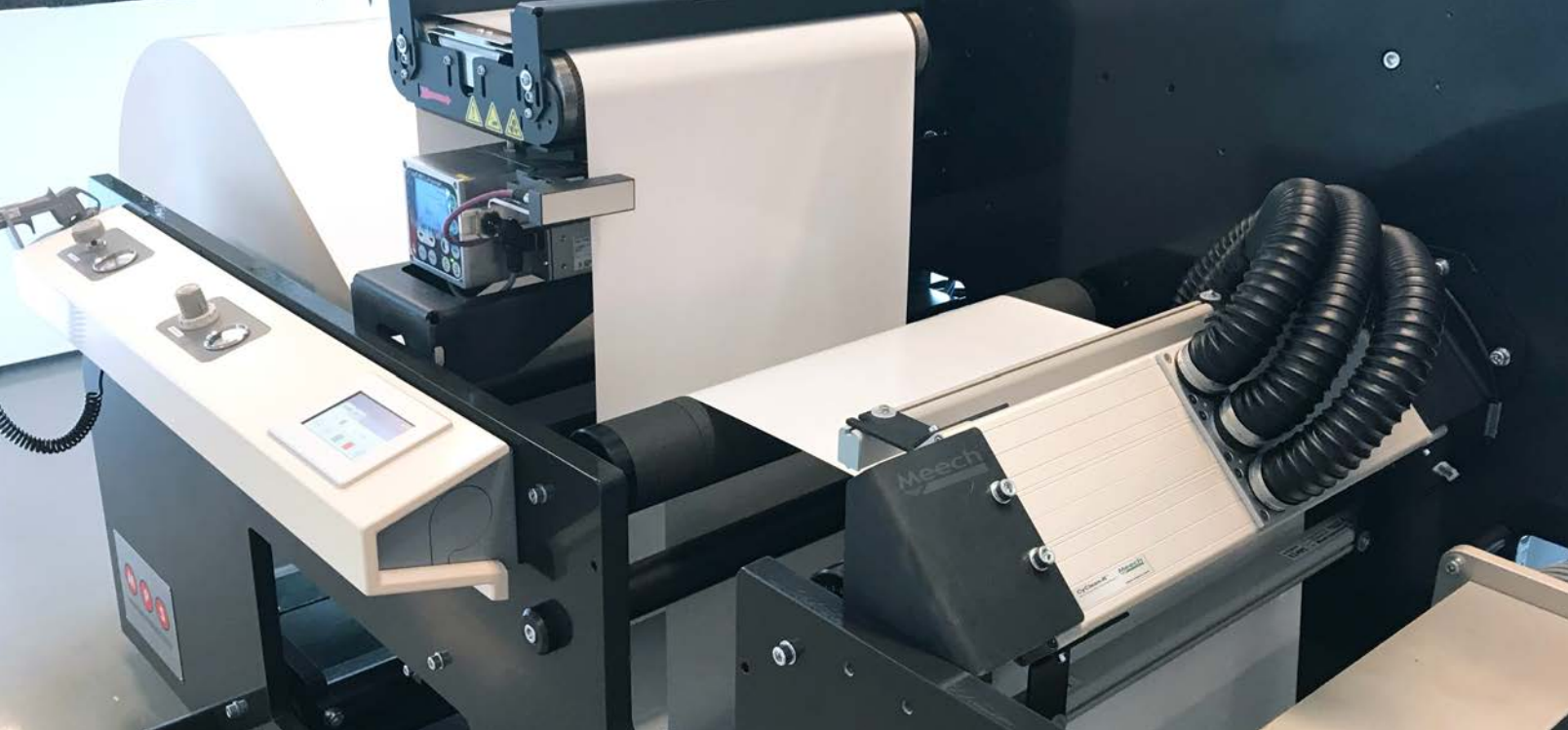

CyClean-R™

Non-Contact Web Cleaning

CyClean-R is available as a single-sided cleaning system, with double-sided cleaning configuration available as an option. The CyClean-R is suitable for high-performance contamination removal from low-tension web applications. It utilises the proven CyClean cleaning philosophy of advanced computational fluid dynamics and bypasses the challenge of low tension webs by cleaning the web on a roller.

The system incorporates powerful positive and negative airflows which break the boundary layer of air on the web, efficiently releasing and removing contamination, leading to a clean surface. The airflows of the CyClean-R are controlled to optimise the cleaning performance.

CyClean-R is supplied with the latest Hyperion™ 924IPS static control bars, to maximise the cleaning performance.

Applications

CyClean-R can be used within a wide variety of applications and as a non-contact system, it is suitable for use with all web materials.

Typical applications include:

- Printing; flexo, digital, gravure and ink jet
- Coating
- Laminating
- Food and medical packaging
- Specialty film processing
- Solar panel substrates
- Battery - aluminium foil
- Blister packs

Installation

The CyClean-R head unit is installed over a guide roller. It may be positioned at any angle to best suit the installation, whilst still delivering uncompromised surface cleaning. The CyClean-R overcomes tension issues, as it is designed to be positioned over a roller, where the tension in the web is naturally at it's highest.

How CyClean-R Works

- The web passes through a cloud of ionisation on entry to the CyClean-R head, which neutralises any static charges on the web.
- The web is then subject to a force of turbulent air created by the blowing and vacuum airflows within the head unit.
- Due to the CyClean-R special head design and positioning, the high velocity positive and negative airflows shatter the web boundary air layer, releasing the contamination into the vacuum airflows.
- As the web exits the CyClean head, it passes through a second cloud of ionisation to prevent re-contamination of the web.



Design Features

The CyClean-R has been engineered to provide exceptional results for low-tension applications across a range of industries.

A range of opening options to suit narrow, mid and wide web applications have been developed to provide an ideal solution, considering a number of factors, including ducting access and space constraints. Our range of system configurations mean that the CyClean-R can be flexible to a number of installations, where other web cleaners may not be suitable.

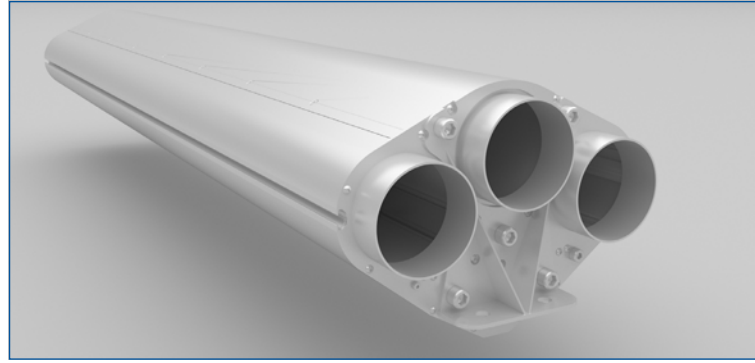

At larger widths of over 1300mm, the CyClean-R includes a top manifold, the 'carapace'. This unique design creates a robust structure that delivers enhanced support for applications up to 9000mm. In addition, the carapace also minimises the use of ducting, leading to a streamlined design.

At larger widths of over 1300mm, the CyClean-R includes a top manifold, the 'carapace'. This unique design creates a robust structure that delivers enhanced support for applications up to 9000mm. In addition, the carapace also minimises the use of ducting, leading to a streamlined design.

Feature	Benefit
Non-contact cleaning	Eliminates risk of surface marking and damage. No interference with web tension or web tracking.
Compact design	Space saving design means CyClean-R can be installed on most machines.
Positioning: cleaning over a guide roller	Avoids web tension challenge and ensures effective non-contact cleaning without the danger of damaging the web.
Unique Shape	The air is forced into a certain direction at extremely high velocity, which enhances its cleaning performance.
Robust design	Can clean up to 9000mm web widths.
Air balancing	Allows complete control of the bias between blowing and vacuum airflows.
Automatic vacuum pressure control	Reduces the frequency of required operator adjustments. Maintains optimum cleaning performance automatically.
No consumable items	Lower ongoing costs.
Quiet operation	Can be installed in enclosed work areas. No H&S issues due to noise.

CyClean-R Configurations

The table below outlines the configurations available, including the opening types, ducting, static control and the AHU required for each. The opening configurations can be seen on page 12-13.

	Web Width (mm)	Opening			Ducting	Qty of 924IPS Bars	Air Handling Units (AHU)
		Fixed	Manual	Pneumatic			
			Option	Option			
Narrow Web	200mm - 699mm	✓	✓	✓	End or Top feed	2	AHUv3 1.1
Mid Web	700mm - 1299mm	✓		✓	2x End feed or 2x Top feed	2	AHUv3 2.2
Wide Web	1300mm - 2399mm	✓		✓	End feed - added carapace	2	AHUv3 3.3
	2400mm - 3999mm	✓		✓	End feed - added carapace	2	AHUv3 6.6
	4000+mm	✓		Special design	End feed - added carapace	4	AHUv3 6.6&3.3

CyClean-R™ System Configurations

In order to best suit your application, we have developed a range of different CyClean-R configurations, considering web width, opening method and ducting connection.

CyClean-R for Narrow Web

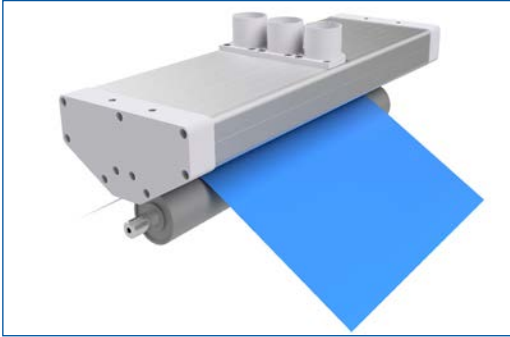

Narrow Web - Fixed: Specification

System Design	Fixed
Ducting Feed	Available as End Feed or TAB Feed
Width Range	200mm - 699mm
Opening range	N/A

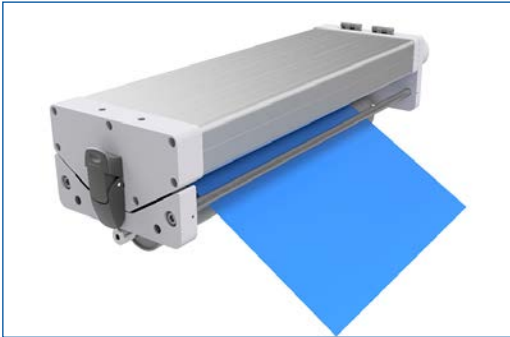

Narrow Web - Manual: Specification

System Design	Manual Lift Opening
Ducting Feed	End Feed
Width Range	200mm - 699mm
Opening range	Maximum 90° from closed position

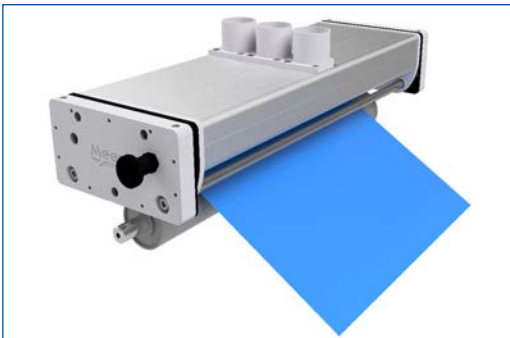

Narrow Web - Manual: Specification

System Design	Manual Tilt Opening
Ducting Feed	TAB Feed
Width Range	200mm - 699mm
Opening range	Maximum 40mm from closed position

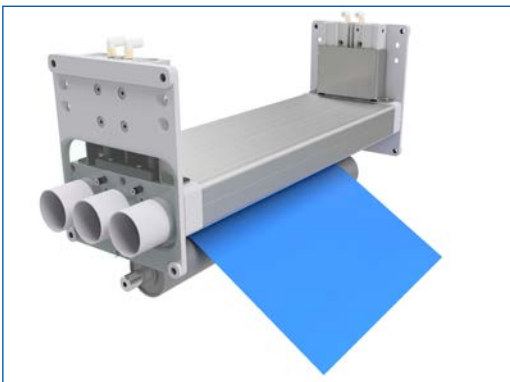

Narrow Web - Pneumatic: Specification

System Design	Pneumatic
Ducting Feed	End Feed
Width Range	200mm - 699mm
Opening range	Maximum 30mm from closed position

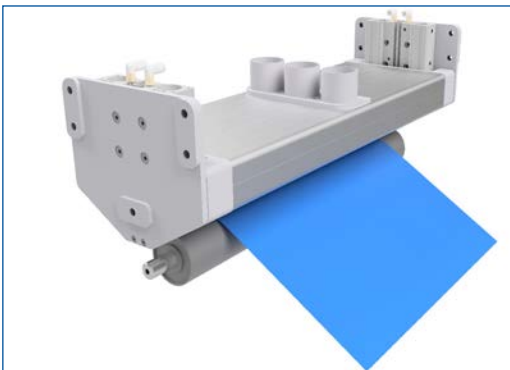

Narrow Web - Pneumatic: Specification

System Design	Pneumatic
Ducting Feed	TAB Feed
Width Range	200mm - 699mm
Opening range	Maximum 30mm from closed position

CyClean-R for Mid Web

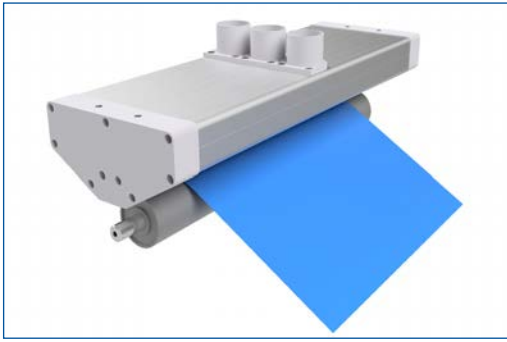

Mid Web - Fixed: Specification

System Design	Fixed
Ducting Feed	Available as 2x End Feed or 2x TAB Feed
Width Range	700mm -1299mm
Opening range	N/A

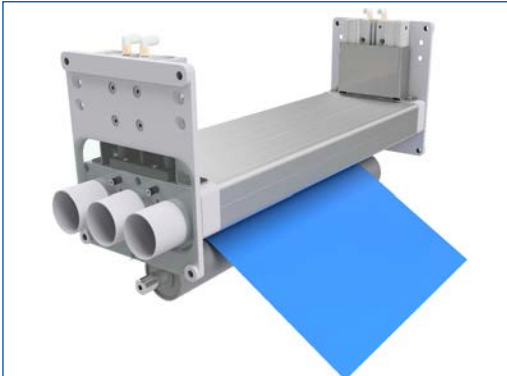

Mid Web - Pneumatic: Specification

System Design	Pneumatic
Ducting Feed	End Feed
Width Range	700mm - 1299mm
Opening range	Maximum 30mm from closed position

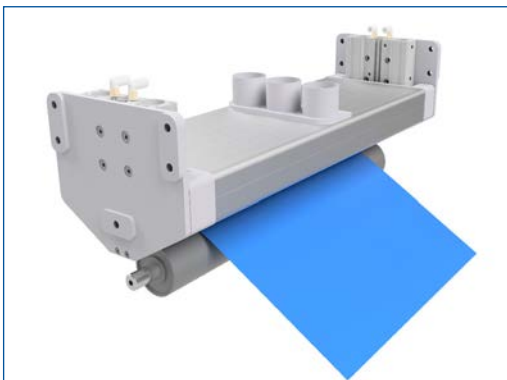

Mid Web - Pneumatic: Specification

System Design	Pneumatic
Ducting Feed	TAB Feed
Width Range	700mm - 1299mm
Opening range	Maximum 30mm from closed position

CyClean-R for Wide Web



Wide Web - Fixed: Specification

System Design	Fixed with carapace, for enhanced rigidity at larger widths
Ducting Feed	End Feed
Width Range	1300mm - 4000mm
Opening range	N/A



Wide Web - Pneumatic: Specification

System Design	Pneumatic tilt opening with carapace, for enhanced rigidity at larger widths
Ducting Feed	End Feed
Width Range	1300mm - 4000mm
Opening range	18mm



RoClean™

Contact Web Cleaning

RoClean is available as a single-sided cleaning system, with double-sided cleaning configuration available as an option. The RoClean is suitable for high-performance contamination removal from low-tension web applications.

The system uses a combination of negative and positive airflows and a rotating bristle brush that breaks the boundary layer from the material surface and removes loose contaminants or contaminants that are bound by electrostatic charges; leading to a clean surface. The airflows of the RoClean are expertly controlled to optimise the cleaning performance.

RoClean is supplied with the latest Hyperion™ 924IPS static control bars, to maximise the cleaning performance.

Installation



The RoClean head unit is installed over a guide roller. It may be positioned at any angle to best suit the installation, whilst still delivering uncompromised surface cleaning. The RoClean overcomes tension issues, as it is designed to be positioned over a roller, where the tension in the web is naturally at it's highest.

How RoClean Works

- The web passes through a cloud of ionisation on entry to the RoClean head, which neutralises any static charges on the web.
- The contact rotary brush rotates in the opposite direction of the web, therefore disturbing the boundary layer of the web and loosening the contaminants which are then extracted into the vacuum chamber. Before the web exits the RoClean, a positive air wave passes over the material, ensuring that any contamination on the rotary brush is also moved to the vacuum chamber. This ensures that when the web exits from the RoClean it is as clean as possible. Contamination is then trapped in the filter located in the Air Handling Unit to prevent airborne contamination.
- As the web exits the RoClean head, it passes through a second cloud of ionisation to prevent re-contamination of the web.

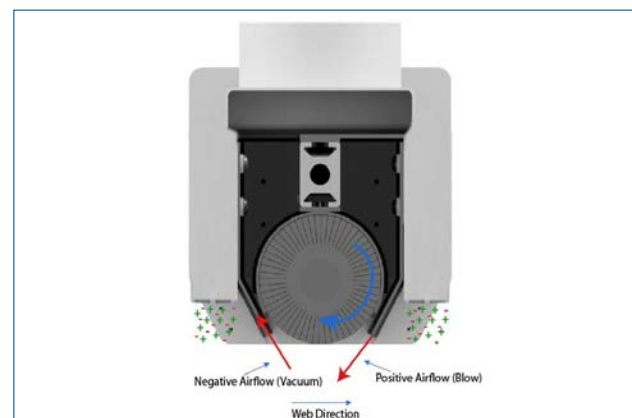

RoClean Web Cleaner (cross section of airflow and brush direction)

Applications

Meech developed RoClean to target the battery film production market where high levels of cleaning efficiency are crucial for the quality of the end product. That said, RoClean is suitable for a range of industrial applications.

RoClean can be used within a wide variety of applications and with the range of bristle material available, it is suitable for use with all web materials.

Typical applications include:

- Battery - Aluminium foil
- Printing: Flexo, Digital, Gravure and Ink-Jet
- Coating
- Laminating
- Food and medical packaging
- Specialty film processing
- Solar panel substrates
- Blister packs

Design Features

The RoClean is a robust, yet compact system. Based on our unrivalled experience and extensive development program, we have included several unique features in the system to ensure excellent performance:

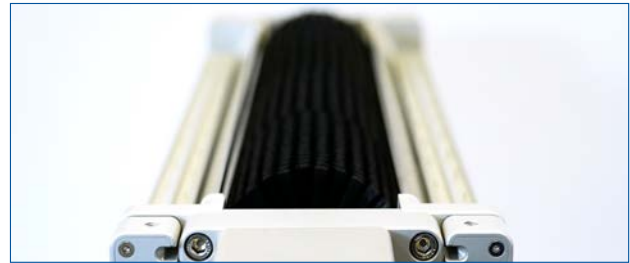

RoClean showing brush

Feature	Benefit
Hyperion™ Pulsed DC Ionising technology offered as standard (integrated)	The latest DC static control technology neutralises the web surface as it enters and exits the RoClean. This reduces the risk of re-contaminating the web.
Adjustable rotary brush height	The height of the rotating brush roller is adjustable up to 5mm, assisting the initial setup and ensuring RoClean is flexible to work with various web thicknesses.
Long rotary brush operating life	Ensures minimum disruption of the production line and maintaining high levels of efficiency.
Easy-change of rotary brushes	The ability to quickly change the rotary brush on RoClean is available from both ends of the unit, ensuring easy access and keeping the idle time to minimum.
Unique feature to clean the rotating brush	Ensures optimum cleaning results
Roller speeds adjustable from the AHUv3	The roller speed is adjusted and maintained by the touchscreen available on the AHUv3*
CleanRoom ISO 7 Class compatible	Specially designed to work in clean and dry room environments**
No compressed air required	Keeps operating cost to a minimum

* Only available when the control panel is included with the system

** Definition of drying room conditions: Purity class according to ISO 14644-1: ISO 7, Ambient Temperature +20 °C ± 2 °C, Dew Point -55 °C ± 2 °C, Room Humidity: <1%

Scope of Supply

Feature	Benefit
Hyperion™ Pulsed DC Ionising technology offered as standard (integrated)	The latest DC static control technology neutralises the web surface as it enters and exits the RoClean. This reduces the risk of re contaminating the web.
Control Panel (optional)	Connects the Air Handling Unit with the RoClean for control via the AHU.
Brushes	Standard brushes made from a low water absorption material that will not risk damage to the material cleaned. Easily removable from both ends of the RoClean. Other materials available on request.
Air Handling Unit (AHUv3 & AHUv3.5)	Provides the positive and negative airflow for the RoClean and the filtration. Additionally provides control over the RoClean. AHUv3.5 is designed to handle toxic contamination.



TakClean™

Contact Web Cleaning

The Meech TakClean contact web cleaning system is designed to remove dry, unbonded contamination from a moving web.

TakClean incorporates the specially formulated TransTak elastomer contact cleaning rollers and perforated adhesive rolls which combined, make TakClean the ultimate elastomer-based web cleaning system.

Meech has designed TakClean to provide the following user advantages:

- Excellent contamination removal – removing particles as small as 0.5 micron.
- Continuous cleaning – no need to stop the web.
- Fast installation – very low downtime for installation.
- Static control – web will be contamination free and neutralised on exit.

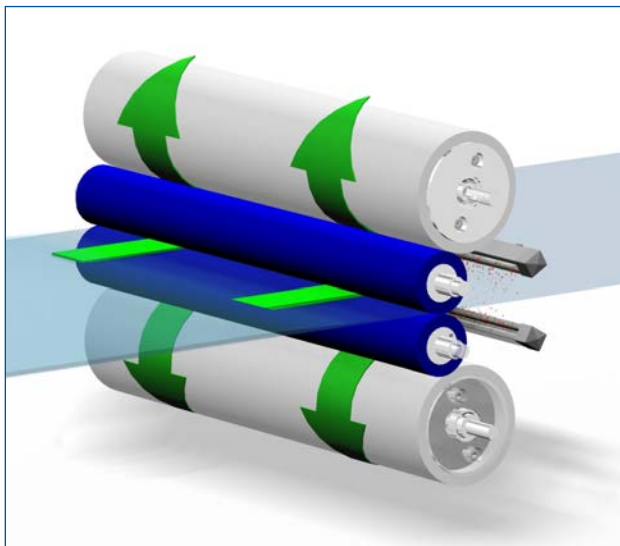

How TakClean Works

The unrivalled cleaning performance of TakClean is the result of 3 critical processes:

- The TransTak elastomer cleaning rollers make contact with the full width of the web with even pressure. Dry, unbonded contamination is lifted from the web surface.
- Pneumatics hold the adhesive roller in contact with the TransTak elastomer roller. Contamination is transferred from the surface of the TransTak elastomer roller to the adhesive roller where it is trapped.
- Any static charge present on the web is neutralised on exit from the TakClean; minimising the risk of statically attracted recontamination.

TransTak Elastomer Rollers

The specially formulated TransTak elastomer rollers are available in a variety of Shore A ratings (35 standard). TransTak rollers include cured silicone, but crucially are proven to have no 'free chemistry' and therefore do not leave any trace on the surface being cleaned.

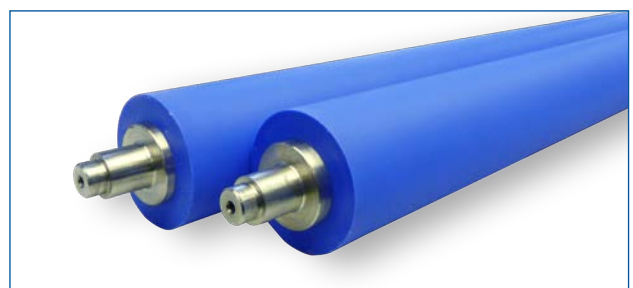

Adhesive Rolls

The quality and performance of the adhesive rolls in any elastomer based web cleaning machine is vital to achieve the best levels of contamination removal.

Meech adhesive rolls are manufactured from a moisture stabilised paper base with a release coating to ensure easy unwinding. The paper is coated with an adhesive which is specially formulated to work effectively with TransTak elastomer rollers. Meech adhesive rollers have a high adhesive mass, the result of which is longer and more effective cleaning.

Meech adhesive rolls are a continuous roll of material with perforations in set positions along the length. The positioning of the perforations gives 70 easily removable (tear off) sections. The major advantages of Meech perforated rolls are as follows:

- A knife is not required to cut the material, leading to improved operator safety and no risk of damage to the TakClean system.
- No wasted adhesive material: the operator only removes a pre-specified length of adhesive roll material.

Adhesive Roll Specification

Material	Paper
Coatweight	High; accurately controlled
Core size	76mm / 3" Ø
Core material	High impact polystyrene
Material length per roll	22.4mtrs / 73ft
Perforations	Roll is perforated into 70 removable sections
Material widths	Any width from 100-1500mm

Design Features

TakClean is constructed from hard anodised aluminium extrusions and machined hard anodised components to provide a highly rigid design with exceptional build quality. In particular TakClean incorporates the following main features:

Feature	Benefit
Clam shell opening (top half) for narrow web	Provides the operator with access to clean the TransTak elastomer rollers and makes webbing-up very easy.
Side pull-out adhesive rolls	Minimises the size of the machine and provides the operator with easy access to remove a section of the perforated adhesive roll.
Cantilever or baseplate mounting	Flexibility of the installation position. TakClean can be installed to suit all web orientations.
Integrated static control	Meech active static control equipment neutralises the web on exit of the TakClean to prevent statically attracted recontamination.
Fast change adhesive rolls	Reduces maintenance time required.

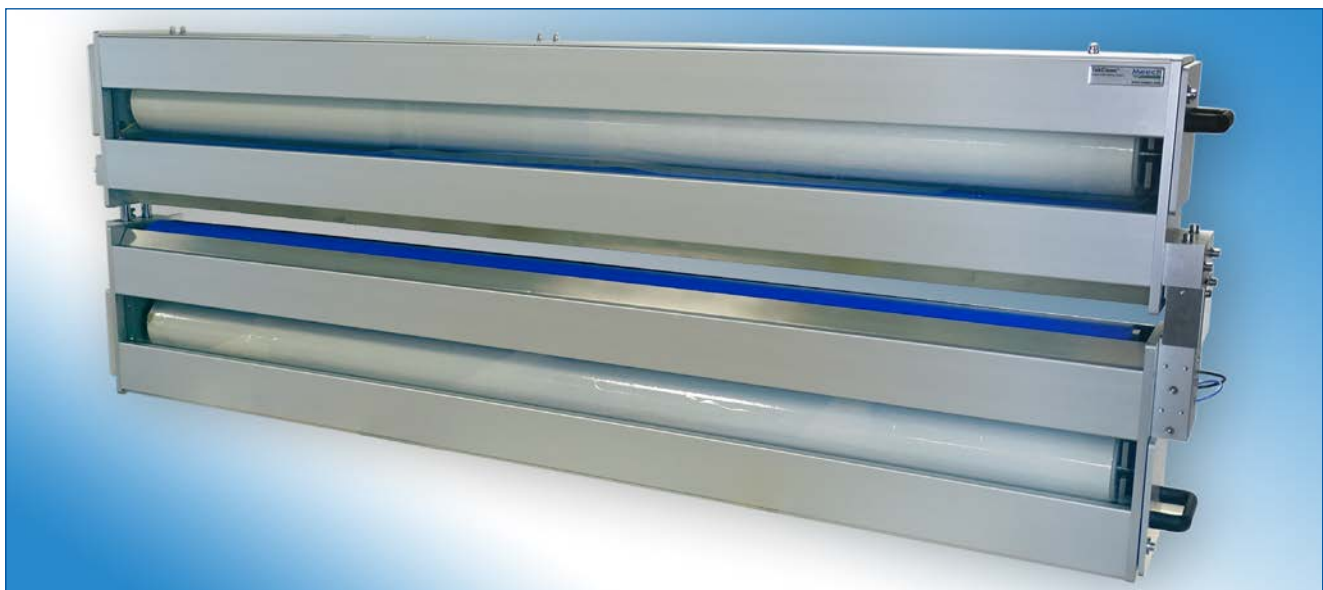

“Working with Meech is an obvious choice for Edale. It enables us to offer integrated solutions to suit our customers’ exacting needs.”

Design Office Manager, Edale

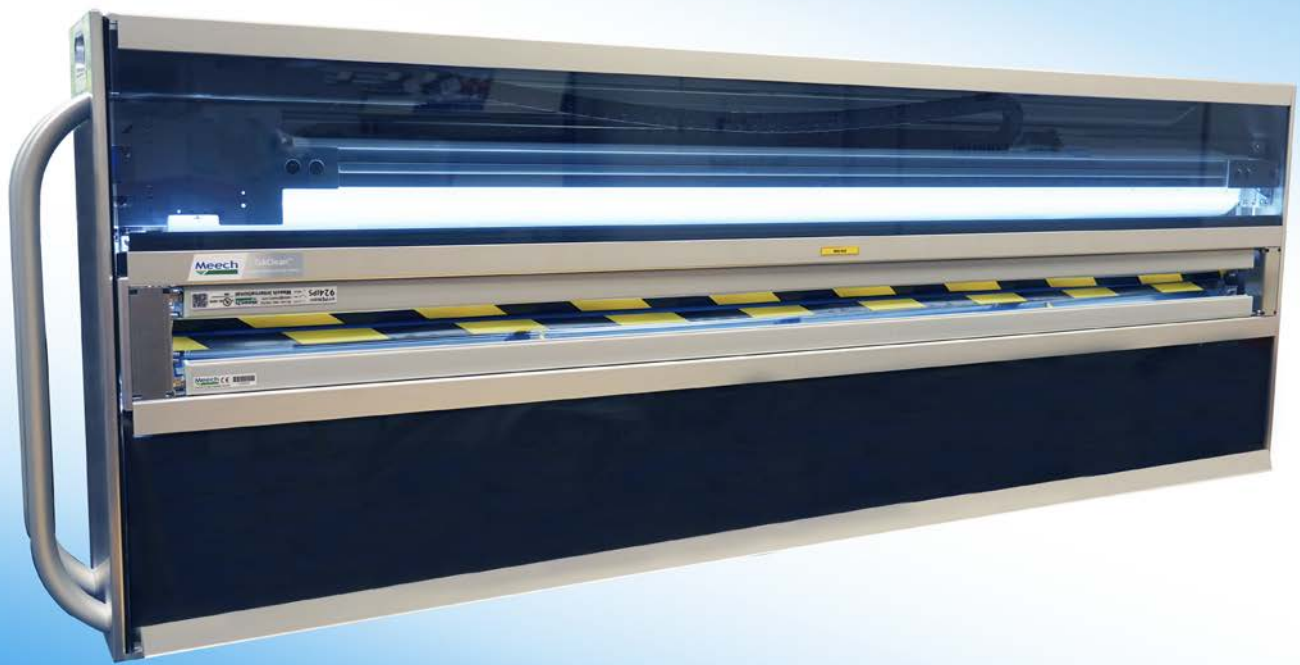

TakClean Ultra™

Contact Web Cleaning

The Meech TakClean Ultra is a re-design of the hugely successful Meech TakClean system.

Manufactured specifically for medium and wide webs between 650 and 1,450mm, the TakClean Ultra was designed following extensive R&D. Built to the highest quality standard, the TakClean Ultra delivers advanced tacky roller cleaning at wider widths.

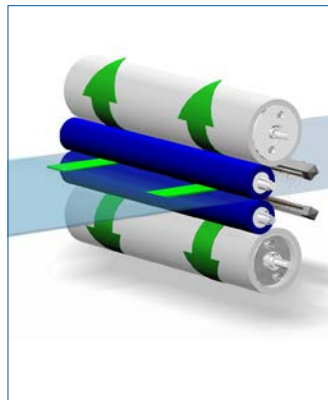

TransTak Elastomer Rollers

The specially formulated TransTak elastomer rollers are available in a variety of Shore A ratings (35 standard). TransTak rollers include cured silicone, but crucially are proven to have no 'free chemistry' and therefore do not leave any trace on the surface being cleaned.



How TakClean Ultra Works

The TakClean Ultra includes a number of new features not seen in the original design, but at its core the TakClean Ultra is still developed from the same tried and tested technology of the TakClean.

- Pneumatics are used to hold the TransTak Elastomer cleaning rollers in place. This allows them to offer an even and consistent level of pressure across the full width of the web. Dry, unbonded contamination is then lifted from the web surface.
- Pneumatics are also used to hold the adhesive roller against the TransTak Elastomer roller. Contamination is transferred from the surface of the TransTak roller to the adhesive roller, where it is trapped.
- Any static present on the web is neutralised on exit from the TakClean Ultra by 2 x Hyperion 924IPS bars. This minimises the risk of recontaminating the web.

■ TakClean Ultra can be webbed up just by disengaging the pneumatic elastomer rollers. This makes the TakClean Ultra more user-friendly and easier to maintain, without the need for tools.



Design Features

TakClean Ultra is constructed from hard anodised aluminium extrusions and machined hard anodised components to provide a highly rigid design, which is crucial when dealing with machinery designed for wide web applications. It also boasts exceptional build quality.

TakClean Ultra has been meticulously designed and engineered to incorporate a number of features within its design, which makes it ideal for a range of different applications using medium and wide webs:



Feature	Benefit
Compact Design	Every component is self contained within the TakClean Ultra, so there is no additional space requirements. This means the TakClean Ultra can fit into areas that require a small footprint.
Hyperion™ Pulsed DC Ionising technology offered as standard	The latest DC static control technology neutralises the web surface as it exits the TakClean Ultra. This reduces the risk of recontaminating the web. Automatic ionisation means the static control will only be switched on when the elastomer roller is engaged. This will increase the life of the static control equipment.
Independent TransTak Elastomer and adhesive rollers	Independent rollers mean that you can disengage the adhesive roller whilst the Elastomer roller is still engaged, allowing for efficient and uninterrupted cleaning. Changing the adhesive roller can be done easily and quickly, reducing downtime and making webbing up easy and contact free.
Automatically adapts to web thickness	Provides flexibility and allows different materials to run on the same production line.
Automatic mode with manual override	Allows the TakClean Ultra to be controlled either manually, via the direct TakClean Ultra controls, or automatically via independent external controls. Both the elastomer and adhesive rolls provide remote signals.
Standard and reverse direction of web travel	The smart design of the TakClean Ultra allows the 924IPS bars to be easily mounted on either side of the unit. This means the direction of the web can be reversed at anytime, providing maximum user flexibility.
Double-sided and single-sided cleaning	To suit a range of applications.
Elastomer rollers separate by 25.4 mm / 1 inch	Making webbing up easy.
Safety Guarding	Provides protection against accidents, whilst also protecting the adhesive rolls from external contamination.
Rollers can be changed without the need for any tools	Allows for quick and easy set-up and maintenance.
Inspection LED	LED lights built into the TakClean Ultra show any contamination left on the web. This allows the user to identify issues immediately.
Hard-wearing	The design of the TakClean Ultra means there is very little wear on parts. This will extend the life of the System.
Self-aligning rollers	Allows easy set up of the pneumatics.

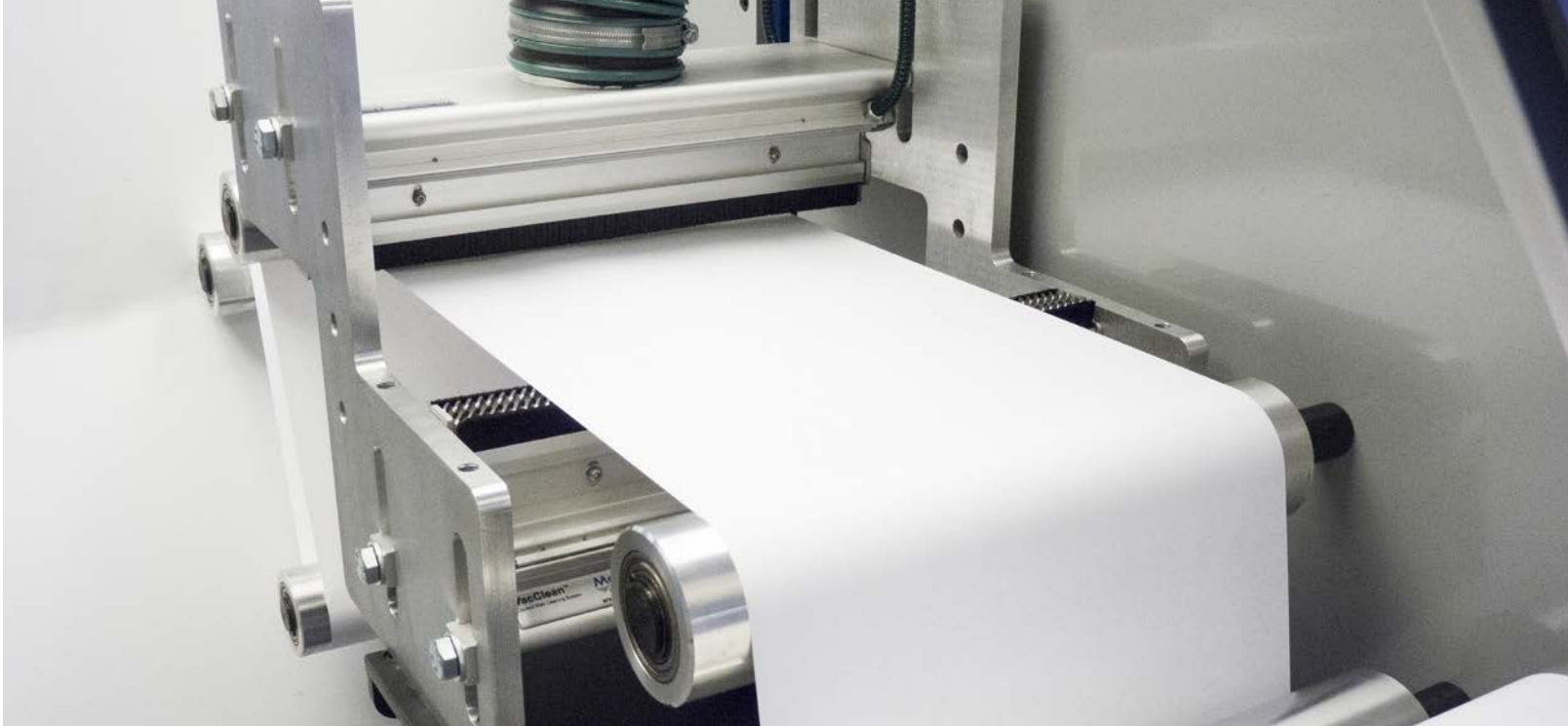

VacClean™

Contact Web Cleaning

The Meech VacClean contact web cleaning system is the ultimate system for the removal of high levels of contamination.

VacClean systems incorporate an enhanced contact cleaning manifold with either an Air Handling Unit (AHUv3) or vacuum fan unit, depending on the installation environment and web width.

Meech engineers created the VacClean manifold profile with the following design characteristics:

- Highly polished stainless steel faceplates which create turbulence to break the boundary layer.
- The delta profile, which is proven to have excellent airflow characteristics, ensuring that removed contamination is efficiently transferred to the system filter.
- A compact web contact point that means VacClean can be installed in areas with restricted space.
- Twin ionising bars, which are angled for an increased ionisation footprint, to neutralise static charges on the web on entry and exit to the manifold.
- Brushes that aid the break-up of the boundary layer without contacting the web surface.

For a combined manifold length up to 1,650mm/65" the VacClean is supplied with an AHUv3, which provides the airflow and filtration for the system.

A combined manifold length of 1,650mm/65" or greater requires the VacClean 3-phase centrifugal vacuum fan unit, which includes an outlet silencer and 5 micron contamination collection bag (upgradable to 1 micron).

If preferred, the vacuum fan unit is also available as an option for installations with a combined manifold length of under 1,650mm/65".

Applications

VacClean can be used in a wide variety of applications where contact cleaning is required. Typical applications include:

- | | |
|----------------------|-------------------------------|
| ■ Printing | ■ Corrugating |
| ■ Labelling | ■ Food / medical packaging |
| ■ Laminating | ■ Paper making / converting |
| ■ Coating | ■ Wood / furniture / flooring |
| ■ Slitting & winding | ■ Automotive |

Installation

The VacClean manifold/s can be installed on a web travelling at any angle without jeopardising cleaning performance. The manifold/s should be installed between rollers (typically no closer than 100mm/4") in an area where the web remains under tension. If the system is double sided, the manifolds should be spaced by a minimum of 80mm/3". The web must be in free air, i.e. away from rollers, conveyors or the machine bed.

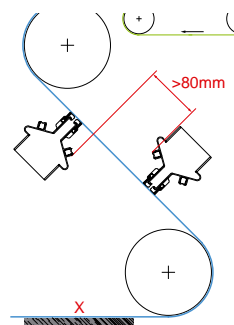

How VacClean Works

- The web passes through a cloud of ionisation which neutralises any static charges present.
- The brushes just contact the surface of the material and break up the boundary layer of air, enabling effective removal of the smallest particles.
- The web then fully contacts two highly polished vacuum faceplates that give complete coverage of the web, creating highly turbulent airflows and concentrating the vacuum to remove contaminants with a very high degree of efficiency.
- As the web leaves the VacClean manifold, it passes through a second cloud of ionisation to prevent re-contamination of the web.

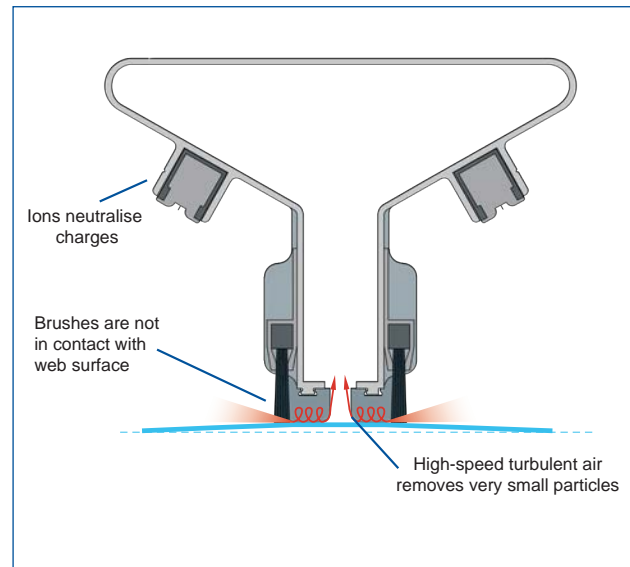
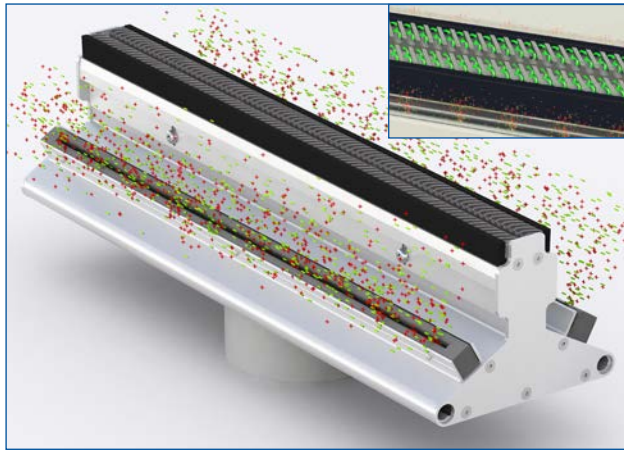

Cross section of VacClean showing operation

Filtration

Excellent filtration is paramount in any web cleaning system. The VacClean system has the following standard filtration levels:

- System including AHUv3 (Compact or Standard) = F8 grade bag filter. Can be upgraded to a H14 grade HEPA filter.
- System including vacuum fan = 5 micron filter bag. Can be upgraded to a 1 micron filter bag.

Design Features

The VacClean manifold is constructed from anodised extruded aluminium, making it highly rigid and suitable for single manifolds to span web widths up to 3980mm, 156". Manifolds can be joined to span wider webs.

Feature	Benefit
Compact contact point	Cleaning in areas of restricted space can be achieved.
Integrated static control	Neutralises static charges to optimise cleaning performance and prevent re-contamination.
Polished stainless steel faceplates	Creates turbulence to break boundary layer and remove contamination.
No consumable items	Low ongoing costs.
Automatic vacuum pressure control	Reduces the frequency of required operator adjustments. Maintains optimum cleaning performance automatically.

Options

VacClean systems can be manufactured to include a range of options including:

- Vacuum fan pre filters to allow fan discharge air to be exhausted to atmosphere.
- Cyclonic dust collection.
- Acoustic enclosures to provide very low vacuum fan noise levels.

"Since installation of the VacClean system we have seen a significant reduction in slitting dust on our final product."

Technical Manager, **Gascogne Paper**



Air Handling Units

The Meech AHU range is integral to the RoClean, CyClean and VacClean systems. The AHU range includes:

- AHUv3 Mini - 1 pump
- AHUv3 Compact - 2 pump
- AHUv3 & AHUv3.5 Standard - 3 pump
- AHUv3 & AHUv3.5 Standard - 6 pump

The AHUv3 provides the positive and vacuum pressure airflows and houses the system filters. It is of robust design and requires minimal maintenance.

Touch Screen Control

The AHUv3 leads in its class. It is fully touchscreen controlled, allowing a clear graphical display of the system settings and status, whilst also making initial setup very fast.

Interlocks and Signals

Meech engineers have provided an interlock for remote start/stop of the AHUv3 to ensure the system is always running during production. Signals for filter condition and to show the system is running are also provided.

Automatic Vacuum Pressure Control

A key feature of the AHUv3 is the Meech automatic vacuum pressure control. This feature has been designed to remove the requirement of ongoing operator adjustment - meaning the operator does not need to monitor the system until the filter condition warning signal is displayed. Critically this feature also means that a consistent level of cleaning is achieved for the full life of the filter, resulting in a consistent end product.

On Board Ionisation

The power supply for the integral ionisation system can be mounted on the rear of the AHUv3. Power for the ionisation power supply is taken directly from the AHUv3, meaning only one main electrical supply is required for the system installation.

Connection with PLC via Meech2PLC

Meech2PLC offers Industry 4.0 interconnectivity. It allows the AHU to be easily integrated into the customer's existing PLC network, for easier access, control and monitoring.

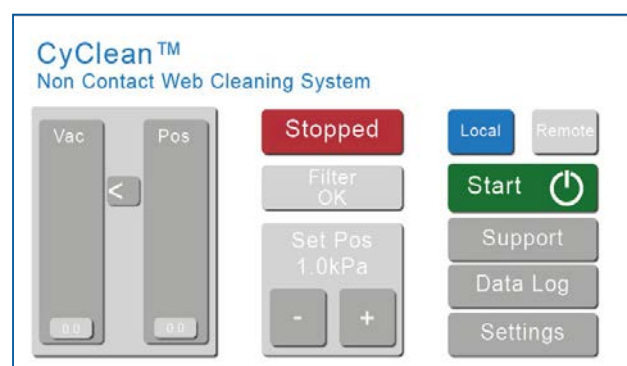

Filtration

Excellent filtration is paramount in any web cleaning system. The Meech AHUv3 range has two levels of filtration:

- F8 Grade Bag Filter
 - Efficiency of 90-95% at 0.4μ or 100% at 1μ
 - Dual layer filter
 - AHUv3 Compact surface area: 0.7m²
 - AHUv3 3 and 6 pump surface area: 2m²

- H14 Grade HEPA Filter
 - Efficiency of 99.997% at 0.3μ
 - AHUv3 Compact surface area: 4.5m².
 - AHUv3 3 and 6 pump surface area: 7.5m²

Filter Capacity Increase

The filter capacity of the Meech AHUv3 range can be increased by adding an optional inline filter unit. This unit is installed as a pre-filter to the AHUv3 and includes one additional F8 grade bag filter.



AHUv3.5

Meech AHUv3.5 has been developed to handle hazardous contamination. It includes all the features of the AHUv3 mentioned above, but has been equipped with additional safety features that do not allow any hazardous contamination to escape into the environment, ensuring the safety of the operators.



Features of AHUv3.5:

- Adapted filter frame with mechanism to secure the filter bag.
- Enhanced seals to prevent internal contamination leaks.
- Rear gate valve to prevent contamination leaks into environment.
- AHUv3.5 only available in 3 and 6 Pumps.

AHUv3 & AHUv3.5 Specification

	Mini -1 Pump		Compact -2 Pumps		AHUv3 -3 Pumps} (AHUv3 and AHUv3.5)		AHUv3 -6 Pumps (AHUv3 and AHUv3.5)	
Output:	1.1kW		2.2kW		3.3kW		6.6kW	
Capacity:	366 m ³ /hr		733 m ³ /hr		1100 m ³ /hr		2200 m ³ /hr	
Weight:	22kg		70kg		95kg		105kg	
Noise level:	68dBa		69dBa		72dBa		78dBa	
Full Load Current:	Neutral	Line	Neutral	Line	Neutral	Line	Neutral	Line
FLC @ 400V:	@240V:7A	@240V:6A	11.3A	8.1A	11.5A	6.9A	23A	13.8A
FLC @ 200V:	@110V:12A	@110V:12A	N/A	17A	N/A	12.5A	N/A	25A
Electrical supply:	240V 1ph		200- 440V 3ph 50/60Hz					
Size (mm):	H520 x D300 x W450		H925 x D450 x W450		H925 x D750 (AHUv3.5 D1120) x W750			
Exhauster:	Turbine Fan							
Filters:	✓		Bag		Efficiency F8		90-95% @ 0.4μ	
	-		HEPA		Efficiency H14		99.997% @ 0.3μ	
	-		Inline		Efficiency F8		90-95% @ 0.4μ	
Stainless steel:	Grade 430							

Environmental Operating Range:

Temperature:	+5°C to +40°C
Humidity:	Max 80 % RH up to 31°C To Max 50% RH at 40°C
Altitude:	Below 2000m
Pollution Degree:	2



Mark Andy

Sales Director Europe

“We specify Meech web cleaning systems on our full range of presses. We selected Meech as it was clear their expertise in web cleaning and related applications matched our high level of knowledge – we can really discuss specific applications with Meech. Our preference is the CyClean non-contact system, but we

know Meech has other technologies on hand if needed. An added benefit is that we also work with Meech for static control, meaning we have a complete ‘clean press’ solution from one partner. Mark Andy and Meech are premium manufacturers and we are both committed to minimising contamination on a press.”

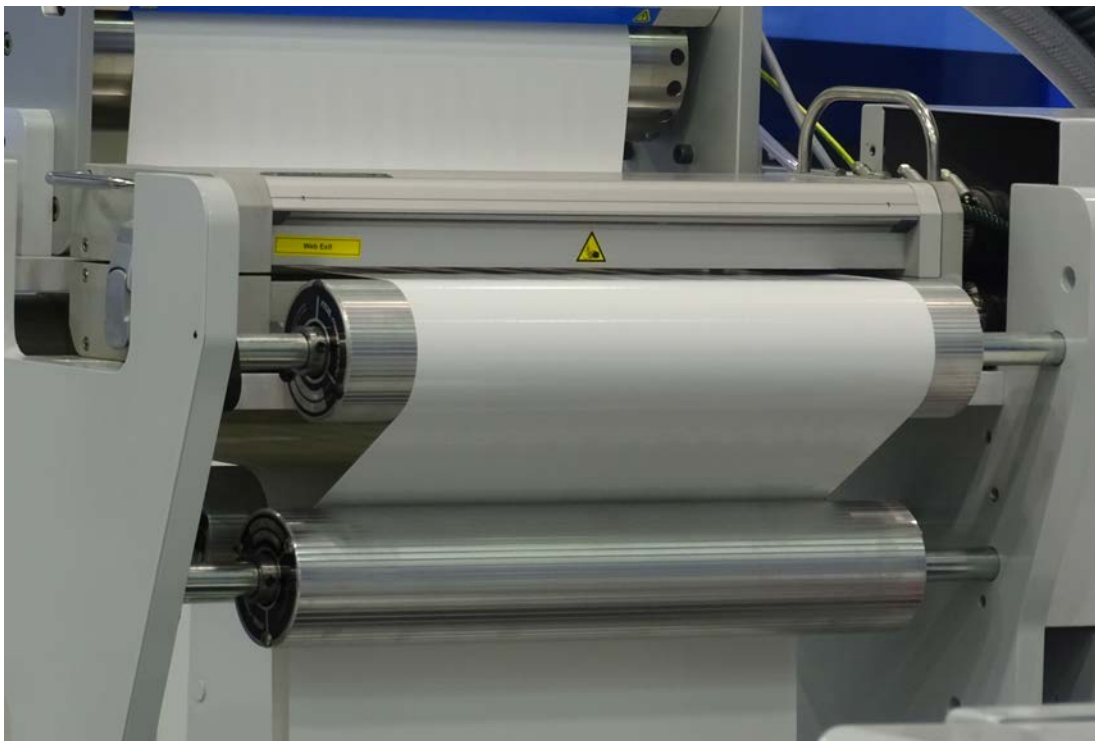



Spartanics

Vice President of Engineering

“Spartanics has partnered with Meech to integrate their Double-Sided TakClean Contact Web Cleaning System with Static Control into our web handling systems used in printing and coating applications. Effective web

cleaning, ease of maintenance / roll changes, and cost effective, compact, stylish design are the attributes that make the Meech TakClean a successful web cleaning solution within our products.”

Xeikon

Product Marketing Director

“As an innovator in digital-printing technology, Xeikon is committed to delivering web-fed digital colour presses of the highest quality, which also means ensuring that our presses are spotless. For this reason, we wanted to partner with a company that understood the importance of minimising contamination and could supply web-cleaning systems that delivered on their promise. Meech ticks both of those boxes.”



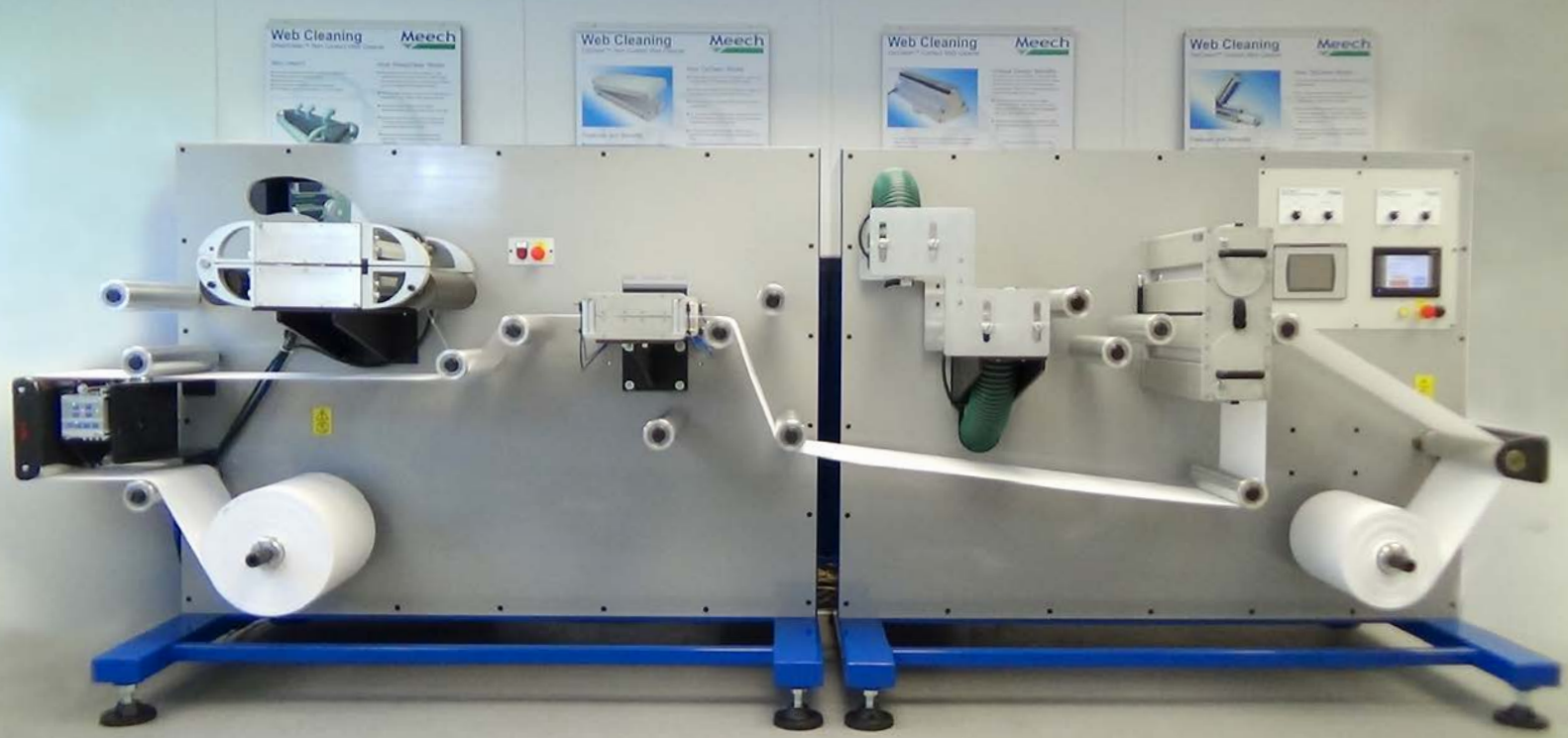

Demonstration and Test Facility

Meech has a web cleaning demonstration and test facility at our head office in the UK and at our USA and China offices. These facilities allow our customers to gain first hand experience of all of the Meech web cleaning technologies.

Customers can bring their own sample material and see the different cleaning levels that can be achieved by each system, allowing the most suitable system for the material to be identified and cleaning performance validated.

Our demonstration and test facilities are also used to train the Meech team and our network of distributors so that you can be sure your Meech partner understands our systems and your needs.



Test Material

If you would like us to test your material, please ensure it meets the following size criteria:

- Web width = 300mm max (12")
- Core diameter = 76mm (3")
- Roll diameter = 450mm max (18")





Web Cleaning
WebClean™ Contact Web Cleaner
Meech
How CyClean Works

Web Cleaning
WebClean™ Contact Web Cleaner
Meech
Unique Circuit Benefits

Web Cleaning
WebClean™ Contact Web Cleaner
Meech
How WebClean Works

All you need, from the best in the business

Meech is also a leading provider of:

- **Industrial Static Control Systems** – Eliminating unwanted static or creating a controlled static charge in industrial processes can increase productivity, reduce waste and enhance quality.
- **ESD** – High sensitivity static control for electronic cleanroom environments to prevent ESD damage and reduce failure rates.
- **Air Technology Equipment** – Compressed air products that save energy, reduce noise levels and provide efficient cooling.
- **Cleaning Systems** – Including JetStream™, IonRinse™ and IonWash™.

Meech International
2 Network Point
Range Road
Witney, Oxfordshire
OX29 0YN
United Kingdom
Tel: +44 (0)1993 706700
Email: sales@meech.com

Meech Static Eliminators (Shanghai)
7G, 7F, LP Tower
#25 Xianfeng Road
201103 Shanghai
China
Tel: +86 400 820 0102
Fax: +86 21 6405 7736
Email: china@meech.com

Meech Elektrostatik SA
Kaiserbaracke 166
B-4780 St. Vith
Belgium
Tel: +32 (0)80 670 204
Fax: +32 (0)80 862 821
Email: mesa@meech.com

Meech CE
Gábor László utca 2
Budapest 1041
Hungary
Tel: +36 1 7977039
+36 30 2803334
Email: ce@meech.com

Meech Static Eliminators USA
1298 Centerview Circle
Akron, Ohio 44321
United States
Tel: +1 330 564 2000
Fax: +1 330 564 2005
Email: info@meech.com

Meech Shavotech
29/2, Kharadi
Off Pune-Nagar Road
Old Kharadi Mundhwa Road
Pune: 411014, Maharastra
India
Tel: +91 (0)703 093 8211
+91 (0)741 000 4817
Fax: +91 (080) 28395963
Email: india@meech.com

Meech International (Singapore)
7 Temasek Boulevard
12 - 07 Suntec Tower One
Singapore
038987
Tel: +65 65918859
Email: singapore@meech.com