

# Operating Manual



**HYPERION™**  
A Meech Innovation

**Hyperion 960IPS**  
Mid-Range DC Bar



# Contents

|  |    |
|--|----|
| Introduction                             | 3  |
| Unpacking and Inspection                 | 4  |
| Contents                                 | 4  |
| Options                                  | 4  |
| Features and Benefits of Hyperion 960IPS | 5  |
| Installation                             | 8  |
| Operation                                | 17 |
| Maintenance                              | 17 |
| Fault Finding                            | 18 |
| Troubleshooting                          | 21 |
| Repairs and Warranty                     | 22 |
| Technical and Construction               | 23 |
| CE Approval                              | 23 |
| Health and Safety                        | 24 |
| Technical Drawing                        | 24 |
| Declaration of Conformity                | 25 |

Products shown in this document may be covered by one or more patents, patents applied for and/or registered designs and/or trade marks. For further information please refer to our Head Office or visit [www.meech.com](http://www.meech.com).

Document version: 3      Software version : 3.07.00

© Meech Static Eliminators Ltd., 04.11.2022



# Introduction

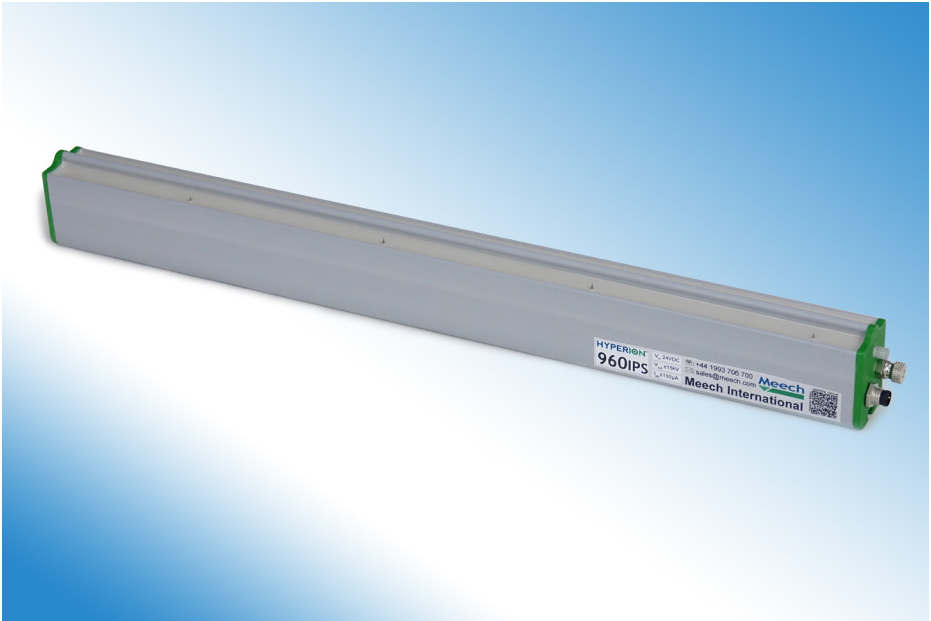

The Hyperion 960 IPS is a powerful, compact pulsed DC ionising bar. It is used to control static electric charges in short to mid-range applications (150-600mm). An integral 15kV pulsed DC power supply allows for easy installation on printing, converting and packaging machinery. Requiring only a 24V DC supply, the 960 IPS removes the need to route high-voltage cabling through the machine.

In most installations the default settings of the bar will provide exceptional static control. The local LED indicator shows the operational status of the bar and advises when the bar requires cleaning.

Demanding installations can take advantage of the adjustable output of the 960 IPS. Using the optional Hyperion BarMaster remote programmer or SmartControl (each sold separately), the frequency, balance and voltage can be optimised to suit the application. Additionally, the Ion Current alarm setting can be changed to guarantee the required performance levels on critical processes, and dual alarm lines enable remote monitoring for system maintenance and faults.

The Hyperion BarMaster remote programmer and SmartControl are available for purchase from the Meech network: Visit [www.meech.com](http://www.meech.com) to find your nearest Meech office or distributor for further product information.

# Unpacking And Inspection

Your Hyperion 960IPS bar was carefully packed at the factory in a container designed to protect it from accidental damage. Nevertheless, we recommend careful examination of the carton and contents for any damage.

If damage is evident, do not destroy the carton or packing material and immediately notify the carrier of a possible damage claim. Shipping claims must be made by the consignee to the delivering carrier.

## Contents:

### Standard



960IPS Bar



Mounting Kit

## Options



Power Cable - 4 Pin M8 (straight or 90° elbow) Available in 2,3,5 and 10M lengths.



24V DC Supply & IEC cable



BarMaster remote programmer. Allows optimisation of the output of the 960 IPS

# Features and Benefits of Hyperion 960IPS

## Low voltage wiring and Integrated Power Supply



The 960IPS is powered by 24V DC via a 4-pin M8 Connector.

## Shockless Emitters

The Titanium emitter pins on the 960IPS are resistively coupled to the high voltage supply. This avoids sparking and operator shocks.

## Sealed Construction

IP66 construction allows the bar to be mounted in areas subject to occasional wash-down or spillage. If the bar does become wet it must be thoroughly dried before being powered-up.

# Clean Pin Alert and Fault LED



The local LED illuminates green to indicate that the bar is on and working correctly. Red flashing LED shows that bar is dirty and needs cleaning. Solid red illumination indicates a fault with the high voltage output.

- Green - OK
- Green flashing - Barmaster remote programmer connected
- Red flashing - Cleaning required
- Red constant - Fault

## Dual Alarm Lines - Clean Pin Alert and Fault Alert Output

Dual alarm lines tell remote monitoring systems whether the ionising equipment needs routine maintenance or whether there is a more serious system failure. The flexible configuration of the alarm system, allows the alarm lines to be interfaced with PLC's, buzzers and remote lamps.

Dual output signals indicate when the bar needs cleaning and when a fault has been detected. The signal is 0V/24V output on pin 2 for Clean Pin Output and 0V/24V output on pin 4 for Fault Alert Output. The default for Bar OK = 24V and for Bar needs cleaning = 0V. For the Fault Alert Output the default is 0V. If required the signal can be inverted using a BarMaster Remote Programmer or SmartControl. For example Bar

6 OK = 0V, Cleaning Required = 24V.



## Divider



The 960IPS is designed to operate in dirty, factory environments. To maximise the interval between cleaning, the bar features a divider to increase the surface tracking distance between the two rows of high voltage pins. It is important to clean this area during cleaning operations.

## T-Slot



The bar is mounted using the T-Slot at the rear of the bar. M4 T-bolts supplied with the bar can be positioned to suit convenient mounting points.

# Installation

## Mechanical Installation

The 960 is a short to mid-range bar. Dependent on the application, the bar will be mounted between 150mm and 600mm from the target surface.

The bar should be mounted securely, using all the M4 T-bolts provided with the bar.

Correct positioning of the bar is vital for effective static control. There must be no metallic objects or obstruction between the bar and the material. The diagram shows the area that should be kept clear.

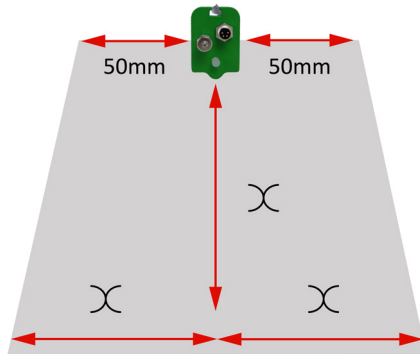

Where X lengths are equal.

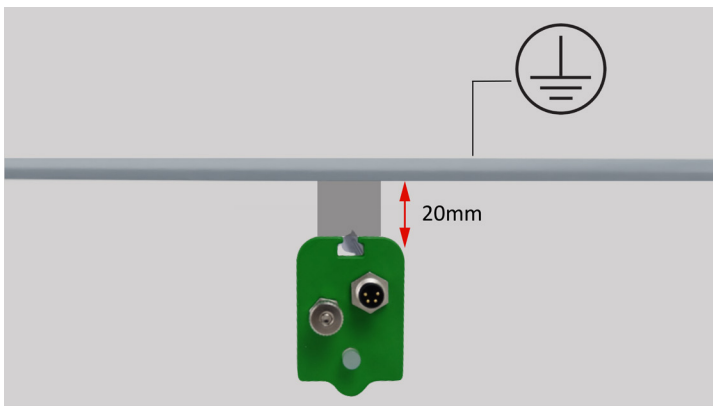

For optimum ionisation performance and maximum emitter pin, the bar should be mounted on insulating mountings 20mm from conductive materials.

When installed at short range over a web or sheet, the bars must be positioned away from surfaces and rollers, as shown in the following diagrams.

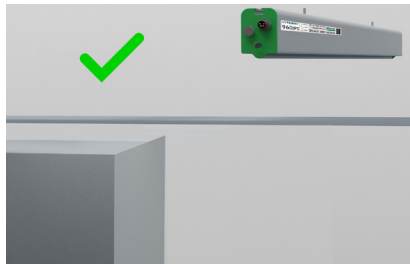
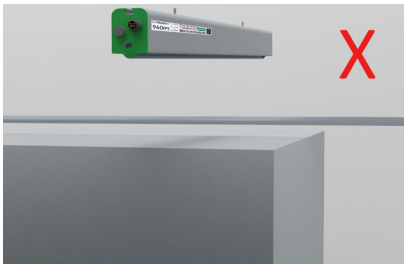
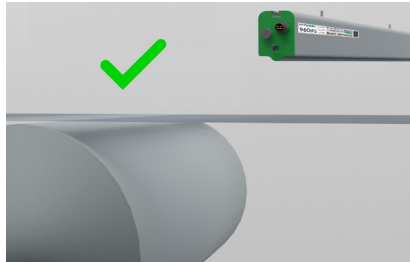
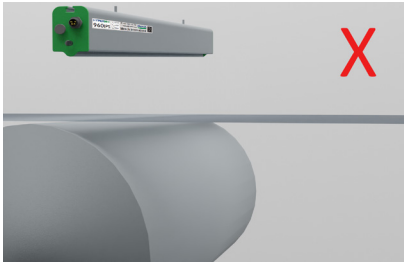

Your Meech distributor will be able to assist with questions regarding positioning of your equipment.

# Electrical Installation

## WARNING

**THIS EQUIPMENT MUST BE GROUNDED VIA THE GROUND / EARTH POST ON THE BAR AND/OR A 24V DC GROUNDED SUPPLY. FAILURE TO SO WILL RESULT IN DAMAGE TO THE BAR OR THE 24V SUPPLY AND WILL VOID THE WARRANTY.**

**Connection using a Grounded 24V DC power supply.** E.g. Meech part number A900IPS-SM2MS.

- Meech 24V DC supplies are grounded internally. They are supplied with a three wire IEC C5 cable.
- The ground connection must be correctly connected at the mains connection.
- The 960IPS should also be grounded by it's grounding post, to provide additional safety.

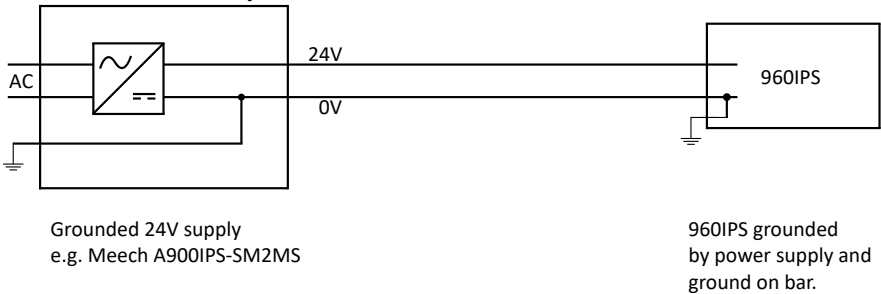

**Connection using an ungrounded 24V DC power supply.**

- The output of many 24V power supplies are not grounded.
- If this type of power supply is used, it is vital that the system is grounded using the ground post on the bar.

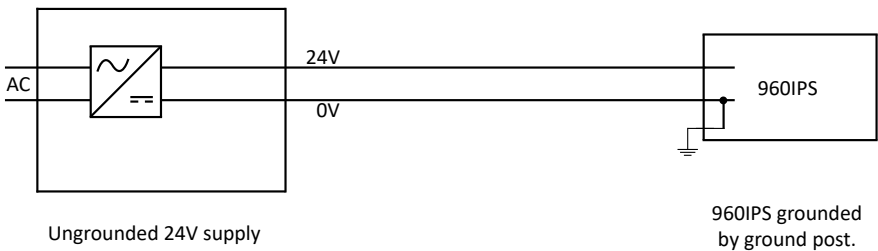

Connection to the 960IPS is via an industrial M8 4 Pin connector. With the following pin-outs:

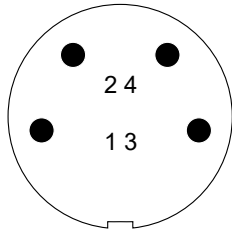

Male connector on Bar

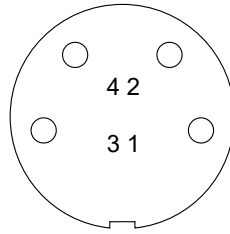

Female connector on Cable

| Pin | Colour | Function Specification                  |
|-----|--------|---|
| 1   | Brown  | 24V (21-27V)                            |
| 2   | White  | Clean Pin & Fault Alert Output 0V / 24V |
| 3   | Blue   | 0V / Ground                             |
| 4   | Black  | Fault alert output 0V/24V               |

## Connection using Meech 24V DC power supply

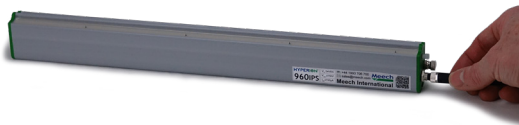

Meech 24V DC supplies are grounded internally. It is important that the mains connection offers a ground connection. Two-pin outlets without a ground connection must not be used, unless the ground post on the 960IPS bar is connected to ground.

The switchmode power supply has a standard IEC C13 mains socket and a 2000mm HT cable to M8 Connector. A break-out wire from the switchmode power supply provides the Clean Pin Alert output signal and fault alert.

## Connection using customer's own power supply:

It is the customer's responsibility to check that the 24V power supply they will be using is grounded. If it is NOT grounded they must check that grounding it via the ground post on the 960IPS bar will not affect any other systems running from that power source.

The 24V supply should be protected with a 1 Amp fuse.

## Dual Alarm Alert - Remote Monitoring

Remote monitoring of the need to clean the bar is provided by the output signal on pin 2 (white) and fault alert is provided on pin 4 (black). The signal is 0V-24V suitable for direct connection to a PLC input. The output impedance of the signal is 10kΩ. The output can also be configured to power an external relay to provide volt-free contacts for other monitoring systems.

Using a BarMaster remote programmer or SmartControl the output can be set to Alarm True = Lo (Normally Open) which is factory default or Alarm True = Hi (Normally Closed).

**NOTE: Make sure that BarMaster is not connected when using the dual alarm remote monitoring feature.**

### Alarm Pins

|               |   |
|---------------|---|
| Pin-2 (White) | This pin is used to report when the HV output of the equipment needs cleaning. This is considered as a warning signal. The LED pattern on the unit is <b>flashing red</b> . |
| Pin-4 (Black) | This pin is used to report when the HV output of the equipment is critically low. This is considered as a serious fault. The LED pattern on the unit is <b>solid red</b> .  |

## Alarm Logic Level

This is given by the configuration of the “Alarm True” setting using the BarMaster.

### ***Alarm True = hi***

This means the logic on both the alarm pins is active high.

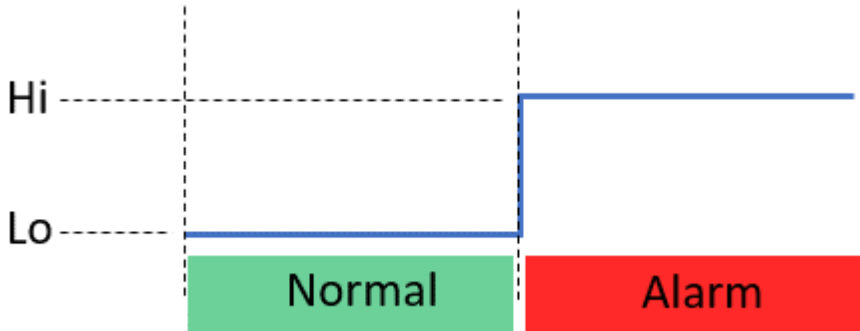

### ***Alarm True = lo***

This means the logic on both the alarm pins is active low.

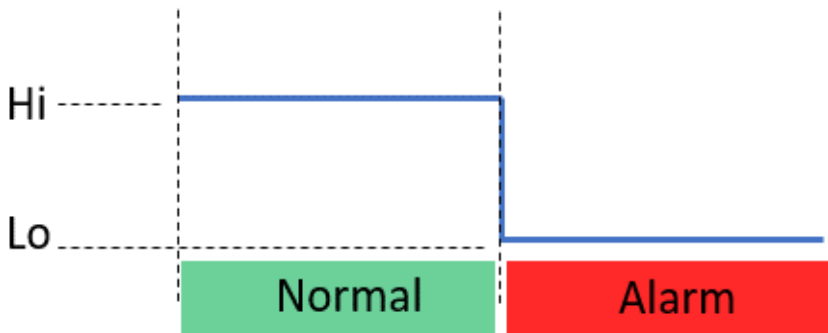

## Output Drive

There are 3 different output drive options which are designed to fulfill the vast majority of user requirements and to allow easy integration to PLC equipment.

### Option 1 - NPN

Transistor-driven switch which presents a pull-up resistor to 24VDC on the alarm pin. This configuration is the same for both alarm pins (pin-2 and pin-4).

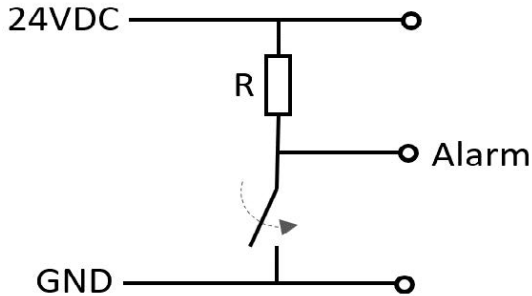

*Simplified Diagram of NPN output*

### Logic Table

#### Alarm True = Hi

|       | Start State | Solid Green | Flashing Red | Solid Red |
|-------|-------------|-------------|--------------|-----------|
| White | Hi          | Lo          | Hi           | Hi        |
| Black | Hi          | Lo          | Lo           | Hi        |

#### Alarm True = Lo

|       | Start State | Solid Green | Flashing Red | Solid Red |
|-------|-------------|-------------|--------------|-----------|
| White | Hi          | Hi          | Lo           | Lo        |
| Black | Hi          | Hi          | Hi           | Lo        |

**Note:** On unit power-up, both alarm pins remain in Hi state for up to 60 seconds before these are used as alarm pins.



## Option 2 - PNP

Transistor-driven switch which presents a pull-down resistor to GND on the alarm pin. This configuration is the same for both alarm pins (pin-2 and pin-4).

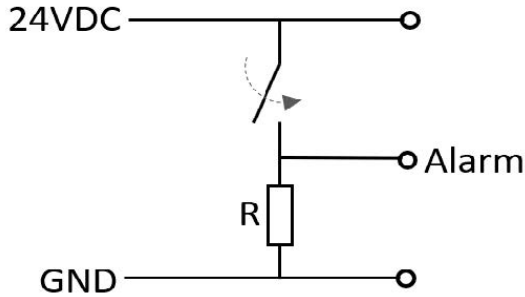

*Simplified Diagram of PNP output*

## Logic Table

### Alarm True = Hi

|       | Start State | Solid Green | Flashing Red | Solid Red |
|-------|-------------|-------------|--------------|-----------|
| White | Hi          | Lo          | Hi           | Hi        |
| Black | Hi          | Lo          | Lo           | Hi        |

### Alarm True = Lo

|       | Start State | Solid Green | Flashing Red | Solid Red |
|-------|-------------|-------------|--------------|-----------|
| White | Hi          | Hi          | Lo           | Lo        |
| Black | Hi          | Hi          | Hi           | Lo        |

**Note:** On unit power-up, both alarm pins remain in Hi state for up to 60 seconds before these are used as alarm pins.

### **Option 3 - N+P**

This option presents the combination of both of the previous cases, NPN and PNP, however, the alarm lines are hard-driven to either 24VDC or GND. This configuration is the same for both alarm pins (pin-2 and pin-4).

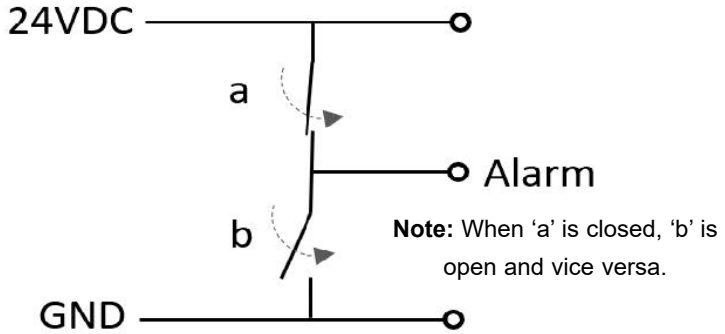

*Simplified Diagram of N+P output*

### **Logic Table**

#### **Alarm True = Hi**

|              | <b>Start State</b> | <b>Solid Green</b> | <b>Flashing Red</b> | <b>Solid Red</b> |
|--------------|--------------------|--------------------|---------------------|------------------|
| <b>White</b> | Hi                 | Lo                 | Hi                  | Hi               |
| <b>Black</b> | Hi                 | Lo                 | Lo                  | Hi               |

#### **Alarm True = Lo**

|              | <b>Start State</b> | <b>Solid Green</b> | <b>Flashing Red</b> | <b>Solid Red</b> |
|--------------|--------------------|--------------------|---------------------|------------------|
| <b>White</b> | Hi                 | Hi                 | Lo                  | Lo               |
| <b>Black</b> | Hi                 | Hi                 | Hi                  | Lo               |

**Note:** On unit power-up, both alarm pins remain in Hi state for up to 60 seconds before these are used as alarm pins.

# Operation

Having connected the M8 connector to the bar, power up the 24V supply and check for a green constant LED on the bar. This indicates that the bar is running correctly with a good ion output.

## Caution

Always turn off the 24V supply before connecting or disconnecting the M8 connector. Failure to do so could result in stored charges giving a small electric shock.

## Output Setup

The 960IPS features a variable output frequency. The frequency that should be set depends on the ionising product and the distance to the target object.

## Voltage

The default setting is 12.5kV. This gives good performance and good emitter pin life. For fast applications the voltage can be increased to its maximum of 15kV. However, this will increase the wear rate of the emitter pins.

## Frequency

The default setting of 5Hz is effective across the whole operating range of 150-600mm. For additional performance from 450mm-600mm range the frequency could be set to 2Hz.

## Balance

At the default 52% the 960IPS neutralises positive and negative static charges accurately to near zero Volts. On applications where the charges are always highly negative, the balance figure can be increased. Conversely if the charge is always positive the balance figure can be reduced. The use of a Meech 983v2 static locator will help assess the effects of this adjustment.

**Important:** After any adjustment is made, clean the ionising bar, as described in the maintenance section, then reset the Ion Reference, to re-calibrate the Ion Current Monitoring system.

# Maintenance

Ionising bars become contaminated with usage. Dirt build-up on the body of the ioniser and, particularly on the pins, will cause a drop in performance. To get the best from your bar, it should be cleaned as part of regular machine maintenance.

If regular cleaning is not carried out, the bar will detect the drop in performance and trigger the Clean Pin alert. The LED will flash red and the output signal will be activated.

Before cleaning, ensure that the equipment is switched off.

Emitter pins can be cleaned very effectively with a brush. A dry toothbrush is ideal.



Ionising bars will need periodic wiping to clean grey deposits from the surface of the bar. A cloth moistened with a small amount of IPA or methylated spirits is recommended.

Let dry for a minute and turn back on.



## Fault Finding

To reduce the time it takes to resolve a problem with a Hyperion product, the following process must be completed before requesting assistance from Meech.

The information below shows what is required for a 960IPS bar however, the same process can be used for any of the Hyperion range of products.





Supplying the following information will ensure your claim is processed quickly when you first contact Meech:



1. Connect to a BarMaster and turn on the equipment
2. A readout will appear on screen and we will require the following information:
  - a. Product Code (i.e. A960IPS-(0320 = bar length))
  - b. Software information
  - c. Frequency
  - d. Balance
  - e. Output voltage
  - f. Alarm %
  - g. Ion Level %
  - h. Reset Ion Ref
  - i. Alarm True (Hi or Lo)
  - j. Output drive
3. Status of the LED (i.e. solid green, flashing red, solid red, flashing green)
4. Please provide a photo of the equipment as it is installed
5. A description and a photo or video of the problem you are experiencing
6. The action you want Meech to take e.g. repair, replace, warranty etc.



# LED Status and Troubleshooting

| Colour  | Meaning                            | Action   |
|---|------------------------------------|--|
| Solid Green<br>    | Normal Operation.<br>Ion Output OK |  |
| Flashing Green<br> | Meaning                            | BarMaster remote programmer is connected.  |
| Flashing Red<br>   | Ion Output below alarm level       | Clean emitter pins and bar (See maintenance section)   |
| Solid Red<br>      | Abnormal Ion Output or HT failure  | Check for extreme contamination. or metallic object on emitter pins. If available Check HT output using High Voltage probe. Check voltage setting using Meech BarMaster. |

## Warning

Do not reset the **Ion Reference** without cleaning the ionising bar first. Resetting the Ion Reference with a low or 0% reading will provide a green LED, but will only mask any problem with the system.

**The 960IPS requires a grounded 24V DC supply & earth stud. The 0V line must be connected to ground. Failure to do so, will result in damage to the bar or the 24V supply and will void the warranty.**

# Repairs And Warranty

The Meech 960IPS Bar is warranted by Meech Static Eliminators Ltd. to the original purchaser against defects in material and workmanship for two years after shipment.

The 960IPS requires a grounded 24V DC supply. The 0V line **must** be connected to ground. Failure to do so, will result in damage to the bar or the 24V supply and will void the warranty.

Should any malfunction occur, please return the bar directly to Meech Static Eliminators Ltd. or your local Meech Distributor. All products returned to the factory **MUST** be accompanied by a return authorisation number and must be shipped prepaid. For prompt service, ship the unit to the factory with the return authorisation number shown clearly on the label. Be sure that it is well packed in a sturdy carton with shock absorbing material.

Include a note stating the nature of the problem as specifically as possible, and also include instructions for returning the bar to you. We will pay one-way return shipping costs on any repairs covered under the warranty.



# Technical and Construction

|                          |   |
|--------------------------|---|
| Output Voltage           | Default +/-12.5kV<br>Adjustable 2-15kV Using BarMaster or SmartControl              |
| Optimum Operating Range  | 150mm – 600mm   |
| Output Frequency         | Default Setting: 5Hz<br>Adjustable 1Hz to 20Hz with BarMaster or SmartControl Touch |
| Output Balance           | Default Setting: 52% Pos<br>Adjustable via BarMaster or SmartControl Touch          |
| Dimensions (W x H)       | 30mm x 45mm   |
| Maximum Length           | 3900mm  |
| Weight                   | 0.9kg/metre   |
| Low Voltage Wiring       | 24V DC Supply - Suits installation on modern machinery                              |
| Integrated Power Supply  | Removes the need for high voltage wiring  |
| Construction             | FR ABS  |
| Mounting                 | 'T' Slot with M4 x 20 studs   |
| Emitters                 | Sharp titanium pins   |
| Input Current            | Max 500mA   |
| Input Voltage            | 24V DC (21-27VDC)   |
| Electrical Connection    | 4 Pole M8   |
| Clean Pin Alert          | 0/24V   |
| Fault Signal Alert       | 0/24V   |
| Environmental Protection | IP66  |
| Max Ambient Temperature  | 60 °C   |

## CE Approval

An EC Declaration of Conformity for this product exists in respect of the Low Voltage Directive:72/23/EEC ("LVD") & Electromagnetic Compatibility Directive: 89/336/EEC 24

# Health and Safety

Emission of Ozone: Considerably below international standard of 0.1ppm.

# Technical Drawing

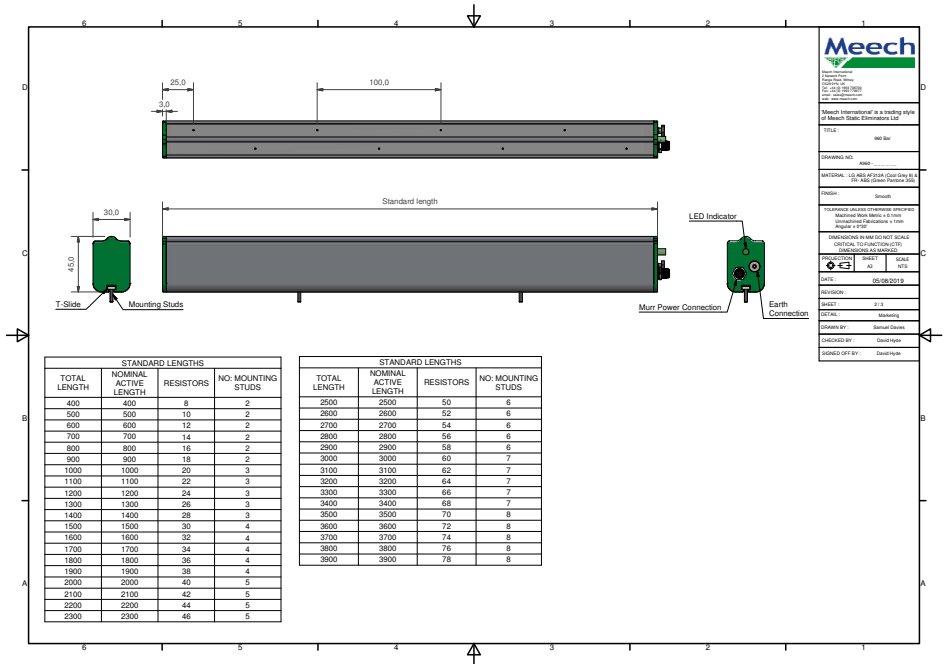

# Declaration of Conformity



## Declaration of Conformity

Equipment

**Model 960IPS Ionising bar**



**Meech International**

2 Network Point  
Range Road, Witney  
OX29 0YN, UK

Tel: +44 (0) 1993 706700

Fax: +44 (0) 1993 776977

email: [sales@meech.com](mailto:sales@meech.com)  
web: [www.meech.com](http://www.meech.com)

### Applicable Harmonised standards

EMCD. EN 61000-6-4:2007+A1:2011  
EN61000-6-2:2005

### EC Council Directives

Electromagnetic Compatibility Directive  
2014/30/EC (Technical File)

On behalf of the above named company, I declare that, on the date the equipment accompanied by this declaration is placed on the market, the equipment conforms with all technical and regulatory requirements of the above listed directives.

A handwritten signature in black ink that reads "J. Ferguson".

.....  
Jon Ferguson, Head of Engineering



#### **Meech International**

2 Network Point  
Range Road, Witney  
OX29 0YN, UK

Tel: +44 (0)1993 706700  
Fax: +44 (0)1993 776977  
email: sales@meech.com

#### **Meech Static Eliminators (Shanghai) Co. Ltd**

7G, 7F, LP Tower  
#25 Xiangfeng Road  
201103 Shanghai  
China

Tel: +86 400 820 0102  
Fax: +86 21 6405 7736  
email: china@meech.com

#### **Meech Static Eliminators USA Inc**

1298 Centerview Circle  
Akron, OH 44321  
USA

Tel: +1 330 564 2000 / 1 800 232 4210  
Fax: +1 330 564 2005  
email: info@meech.com

#### **Meech Shavotech**

29/2, Kharadi  
Off Pune-Nagar Road  
On Old Kharadi Mundhwa Road  
Pune : 411014 , Maharashtra  
India

Tel: +91 (0)703 093 8211 / +91 (0)741 000 4817  
Fax: +91 (080) 28395963  
email: india@meech.com

#### **Meech Elektrostatik SA**

Kaiserbaracke 166  
B-4780 St.Vith  
Belgium

Tel.: +32 (0)80 670 204  
Fax: +32 (0)80 862 821  
email: mesa@meech.com

#### **Meech International (Singapore) Pte. Ltd.**

7 Temasek Boulevard  
12 - 07 Suntec Tower One  
Singapore  
038987

Tel: +65 65918859  
email: singapore@meech.com

#### **Meech CE**

Gábor László utca 2  
Budapest 1041  
Hungary

Tel: +36 1 7977039  
+36 30 2803334  
email: ce@meech.com