

15kV

v1.50



**Operating Manual**  
**Hyperion 971IPS-15**  
Long-Range DC Bar



# Contents

|                                |    |
|--------------------------------|----|
| Introduction                   | 3  |
| Unpacking and Inspection       | 4  |
| Contents                       | 4  |
| Standard Equipment             | 4  |
| Optional Equipment             | 4  |
| Features of Hyperion 9711PS-15 | 5  |
| Installation                   | 10 |
| Operation                      | 15 |
| Maintenance                    | 15 |
| Fault Finding                  | 17 |
| Troubleshooting                | 19 |
| Repairs and Warranty           | 20 |
| CE Approval                    | 20 |
| UL Approval                    | 20 |
| Health and Safety              | 21 |
| Technical Characteristics      | 21 |
| Technical Drawing              | 22 |

Products shown in this document may be covered by one or more patents, patents applied for and/or registered designs and/or trade marks. For further information please refer to our Head Office or visit [www.meech.com](http://www.meech.com).



# Introduction

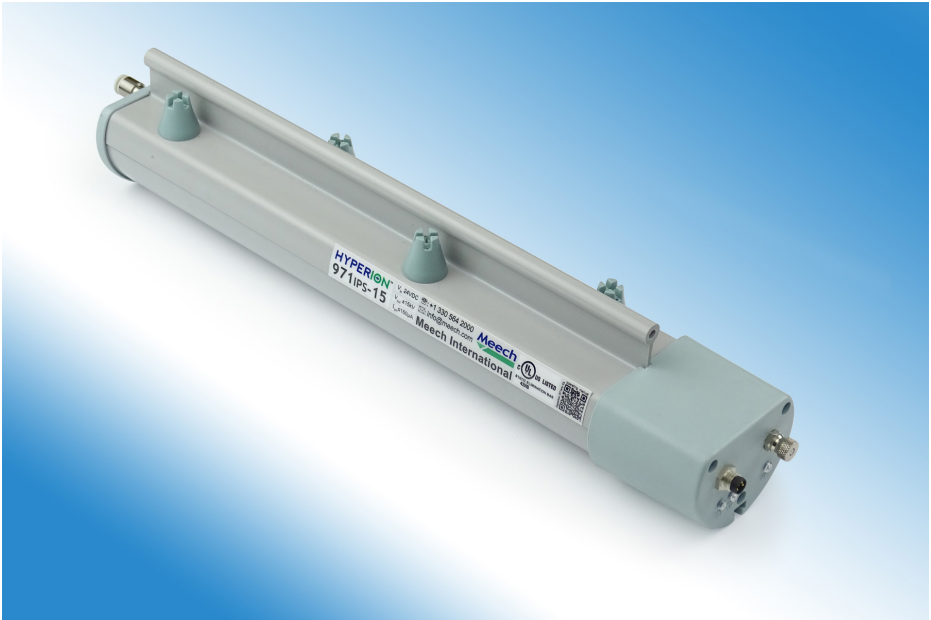

The Hyperion 971IPS-15 is a powerful, pulsed DC ionising bar. It is used to control static electric charges in mid to long-range applications (150-900mm). An integral 15kV pulsed DC power supply allows for easy installation on printing, converting and packaging machinery. Requiring only a 24VDC supply, the 971IPS-15 removes the need to route high-voltage cabling through the machine.

In most installations the default settings of the bar will provide exceptional static control. The local LED indicators show the operational status of the bar and advises when the bar requires cleaning.

Demanding installations can take advantage of the adjustable output of the 971IPS-15.

Using the optional Hyperion BarMaster remote programmer, the frequency and balance can be optimised to suit the application. Additionally, the Ion Current alarm setting can be changed to guarantee the required performance levels on critical processes.

The Hyperion BarMaster remote programmer is available for purchase from the Meech network: Visit [www.meech.com](http://www.meech.com) to find your nearest Meech office or distributor for further product information.

# Unpacking And Inspection

Your Hyperion 971IPS-15 bar was carefully packed at the factory in a container designed to protect it from accidental damage. Nevertheless, we recommend careful examination of the carton and contents for any damage.

If damage is evident, do not destroy the carton or packing material and immediately notify the carrier of a possible damage claim. Shipping claims must be made by the consignee to the delivering carrier.

## Contents:

### Standard Equipment



971IPS-15 Bar



Mounting Kit

### Optional Equipment



Power Cable - 4 Pin M8  
(straight or 90° elbow)

Available in 2,3,5 and 10M lengths.



24VDC Supply & IEC  
cable



BarMaster remote  
programmer.

Allows optimisation of the output of the 971IPS-15

# Features and Benefits of Hyperion 971IPS-15

## Low voltage wiring and Integrated Power Supply



The 971IPS-15 is powered by 24VDC via a 4-pin M8 Connector.

## Overall look

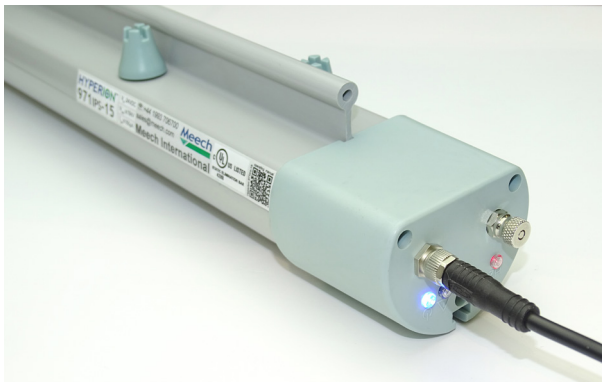

The profile of the Hyperion 971IPS-15 bar is rounded, with minimal dirt traps, making it useful for cleanroom applications. The bar has good rigidity, allowing it to span wide widths. Mounting is by M4x20 T bolts in a slot at the rear of the bar.

## Shockless Emitters

The Titanium emitter pins on the 971IPS-15 are resistively coupled to the high voltage supply. This avoids sparking and operator shocks.

## Sealed Construction

IP64 or IP65 construction allows the bar to be mounted in areas subject to occasional wash-down or spillage. If the bar does become wet it must be thoroughly dried before being powered-up.

## Emitter Assembly

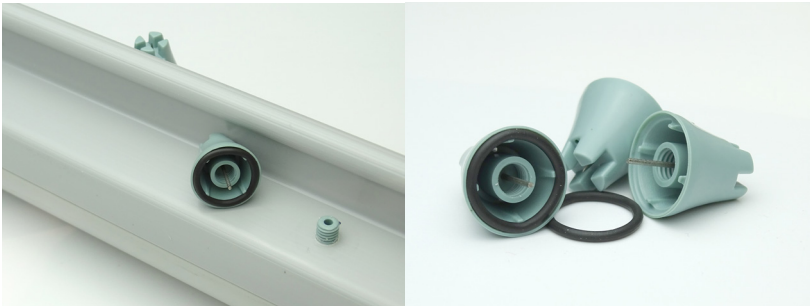

The emitter assembly is a one piece moulding with a 1mm diameter sharp titanium emitter pin. The use of titanium pins has a long history at Meech. Extremely hard wearing, the pins last for many years. The emitter features castellation that protects the operator from the point of the emitter. The castellation also allows very easy cleaning of the pin using a brush. This is a great improvement on other pulsed DC bars. The open design of the emitter also gives a performance boost over previous systems.



## Meech Emitter Key and Replacement Emitters



Replacement emitters are available in bags of ten. Each bag includes an emitter key to allow their easy removal and re-fitting.

## Air-Boost

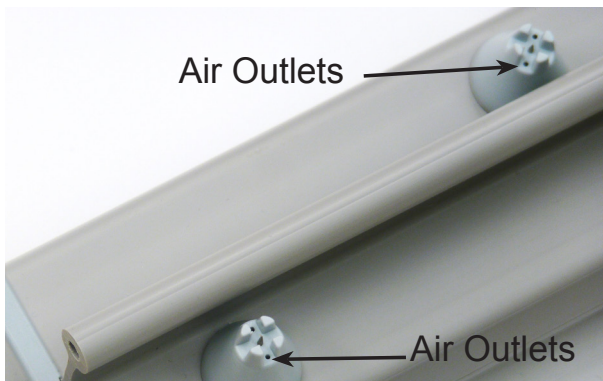

Whilst the long range performance of the Hyperion 971IPS-15 is excellent, some installations can require the use of air assistance to get full control of the static. This can either be by increased speeds of decay and/or by increased ionisation range. Air outlets either side of the emitter pin ensure that the integrated air-boost is extremely efficient. Each 971IPS-15 bar is supplied with a 6mm push-fit air fitting pre-installed.

## Clean Pin Alert LED and Fault Output

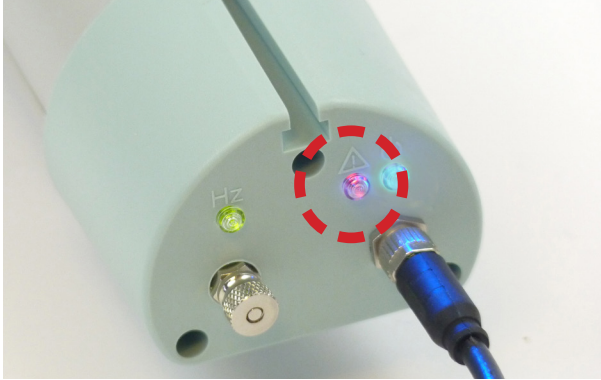

Red flashing LED shows that bar is dirty and needs cleaning. Solid red illumination indicates a fault with the high voltage output.

- No light - OK
- Red flashing - Cleaning required
- Red constant - Fault

The signal is 0V/24V output on pin 2. By default: Bar OK = 24V, Bar needs cleaning (or fault detected) = 0V. If required the signal can be inverted to give OK = 0V, Cleaning Required = 24V using a Barmaster Remote Programmer

## Frequency Indicator

A red/green LED flashes in time with the HT outputs, giving a visual indication of the bar's setup

## Remote Signal

In the case of the Cleaning Alert LED activating, the Clean Pin Alert signal will activate. This can be monitored remotely to alert the operator to attend to the bar.

## Divider

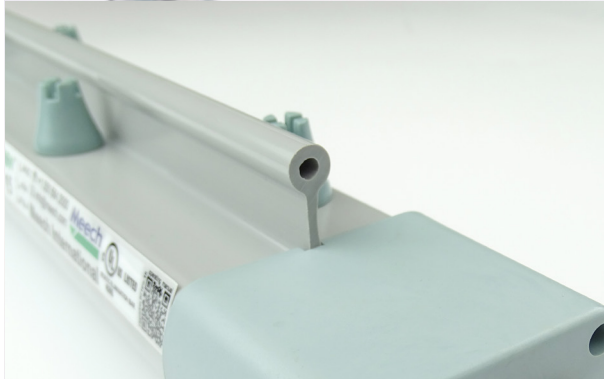

The divider used on all Meech pulsed DC bars is an essential feature that ensures good operation in dirty, factory environments. To maximise the interval between cleaning the 9711PS-15 bar features a divider to increase the surface tracking distance between the two rows of high voltage pins. It is important to clean this area during cleaning operations.

## T-Slot



The bar is mounted using the T-Slot at the rear of the bar. M4 T-bolts supplied with the bar maybe positioned to suit convenient mounting points.

| Feature                        | Benefit   |
|--------------------------------|---|
| Powerful long range ionisation | Excellent static control on modern, fast machinery  |
| Rigid profile                  | Minimises the number of mounting points required    |
| Resistive coupling             | Safe for operators to handle                        |
| Titanium emitter pins          | Continue to give good ionisation after years of use |
| Replaceable emitter assemblies | Allows periodic replacement to extend service life  |
| 'T' slot mountings             | Provides complete flexibility of mounting points    |
| Integrated air-boost           | Increased performance for demanding applications    |

## Installation

### Mechanical Installation

The 971IPS-15 is a medium to long-range bar. Dependent on the application, the bar will be mounted between 150mm and 900mm from the target surface.

The bar should be mounted securely, using all the M4 T-bolts provided with the bar.

Correct positioning of the bar is vital for effective static control. Ideally, there should be no metallic objects or obstruction between the bar and the material. The diagram shows the area that should be kept clear.

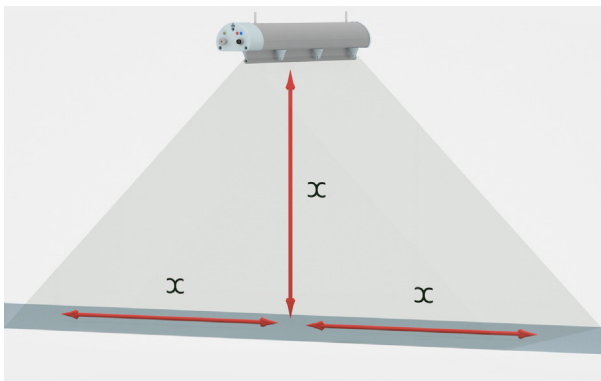

Where X lengths are equal.

Your Meech distributor will be able to help you with the best position for your installation.

When installed at short range over a web or sheet, the bars must be positioned away from surfaces and rollers, as shown in the following diagrams.

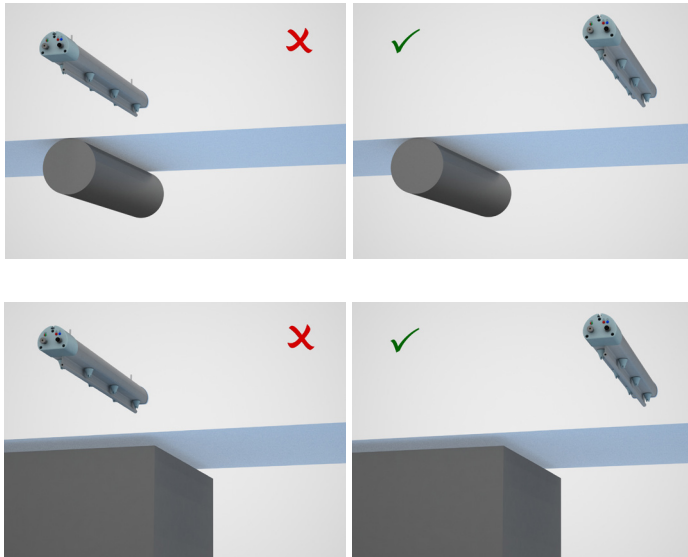

Your Meech distributor will be able to assist with questions regarding positioning of your equipment.

# Electrical Installation

## WARNING

The 971IPS-15 requires a grounded 24V DC supply. The 0V line **must** be connected to ground. Failure to do so, will result in damage to the bar or the 24V supply and will void the warranty.

A grounding post on the bar is provided for this purpose. Meech recommend that, for certainty, the bar is grounded using this post, in addition to using a grounded 24V DC supply.

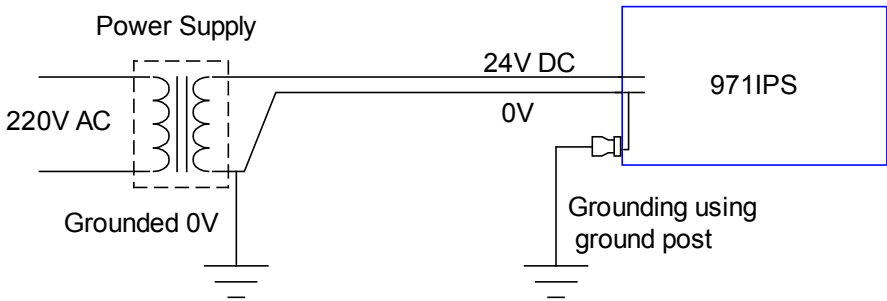

Connection to the 971IPS-15 is via an industrial M8 4 Pin connector. With the following pin-outs:

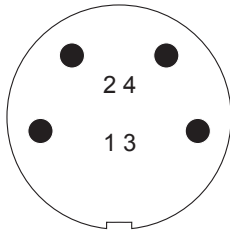

Male connector on Bar

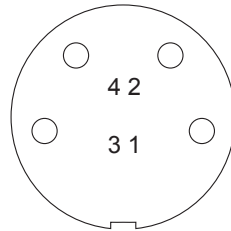

Female connector on Cable

| Pin | Colour | Function Specification  |
|-----|--------|-------------------------|
| 1   | Brown  | 24V (21-27V)            |
| 2   | White  | Clean Pin Output 0V/24V |
| 3   | Blue   | 0V/ Ground              |
| 4   | Black  | No connection           |

## Connection using Meech 24VDC power supply



Meech 24V DC supplies are grounded internally. It is important that the mains connection offers a ground connection. Two-pin outlets without a ground connection must not be used, unless the ground post on the 971IPS-15 bar is connected to ground.

The switchmode power supply has a standard IEC C13 mains socket and a 2000mm HT cable to M8 Connector. A break-out wire from the switchmode power supply provides the Clean Pin Alert output signal.

### Connection using customer's own power supply:

It is the customer's responsibility to check that the 24V power supply they will be using is grounded. If it is NOT grounded they must check that grounding it via the ground post on the 971IPS-15 bar will not affect any other systems running from that power source.

The 24V supply should be protected with a 1 Amp fuse.

### Clean Pin Alert - Remote Monitoring

Remote monitoring of the need to clean the bar is provided by the output signal on pin 2. The signal is 0V-24V suitable for direct connection to a PLC input. The output impedance of the signal is 10k $\Omega$ . The output can also be configured to power an external relay to provide volt-free contacts for other monitoring systems.

Using a BarMaster remote programmer the output can be set to Normally Open (factory default) or Normally Closed.

## PLC Wiring

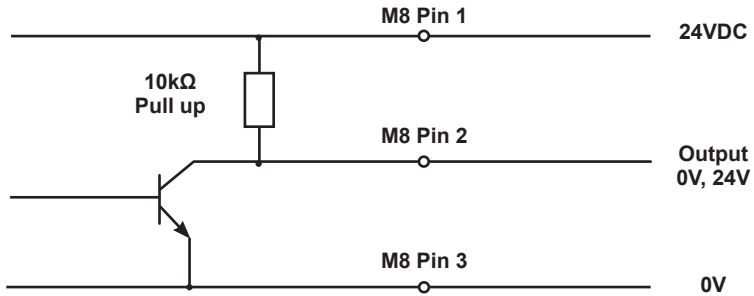

### Output Signal Voltage

Normally Open Output Matrix

|                        | 24V Supply Power ON | 24V Supply Power OFF |
|------------------------|---------------------|----------------------|
| OK (Green LED)         | 24V                 | 0V                   |
| Dirty/Faulty (Red LED) | 0V                  | 0V                   |

Normally Closed Output Matrix

|                        | 24V Supply Power ON | 24V Supply Power OFF |
|------------------------|---------------------|----------------------|
| OK (Green LED)         | 0V                  | 0V                   |
| Dirty/Faulty (Red LED) | 24V                 | 0V                   |

## External Relay Wiring

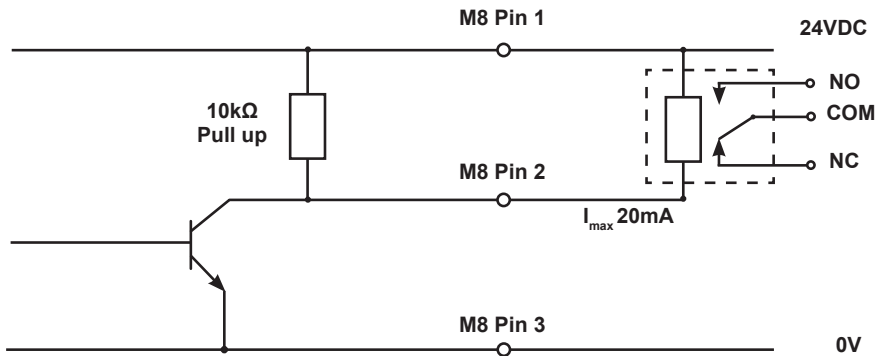

### Relay Power

Normally Open Output Matrix

|                        | 24V Supply Power ON | 24V Supply Power OFF |
|------------------------|---------------------|----------------------|
| OK (Green LED)         | OFF                 | OFF                  |
| Dirty/Faulty (Red LED) | ON                  | OFF                  |

Normally Closed Output Matrix

|                        | 24V Supply Power ON | 24V Supply Power OFF |
|------------------------|---------------------|----------------------|
| OK (Green LED)         | ON                  | OFF                  |
| Dirty/Faulty (Red LED) | OFF                 | OFF                  |



# Operation

Having connected the M8 connector to the bar, power up the 24V supply and check for a blue constant LED on the bar. This indicates that the bar is running correctly with a good ion output.

## Caution

Always turn off the 24V supply before connecting or disconnecting the M8 connector. Failure to do so could result in stored charges giving a small electric shock.

# Maintenance

Ionisers require periodic cleaning. During normal operation, dirt will build-up on the emitter pins and upon the body of the ioniser. This will cause a reduction in performance.

Typically, weekly cleaning is sufficient. However, equipment used in some heavy contamination areas, such as gravure printing or where plastic fumes are present, may require daily cleaning. Equally, in a Class 100 area, cleaning may only be required on a monthly basis. The performance monitoring of the 971IPS-15, will alert the operator to the need to clean the equipment before performance drops to an unacceptable level.

Before cleaning, ensure that the equipment is switched off.

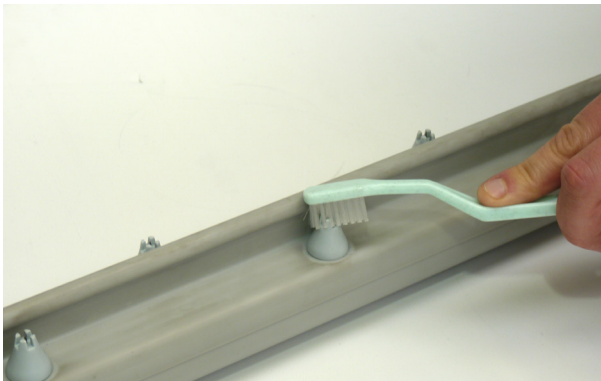

To maintain good performance, regular cleaning of all ionising bars is required. The open design of the 971 emitter head allows for easy and effective cleaning with a brush, making removal unnecessary. A dry toothbrush is ideal.

**NOTE:** The emitter pins on 971IPS bars should not be removed for cleaning.

Ionising bars will need periodic wiping to clean grey deposits from the surface of the bar. A cloth moistened with a small amount of IPA or methylated spirits is recommended.

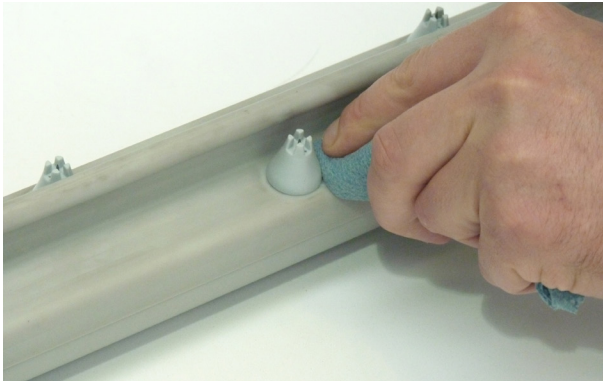

Let dry for a minute before turning back on.



After prolonged use, perhaps after several years, the emitter pins may become worn and require replacement. Bags of replacement pins are available from Meech and are supplied with a special insertion tool.

### **Important!**

1. When replacing the emitters, only use the Meech Insertion Tool. No other tools should be used.
2. The emitters should only be tightened finger-tight. Over-tightening the emitters will stress them unnecessarily and may cause failure.

# Fault Finding

To reduce the time it takes to resolve a problem with a Hyperion product, the following process must be completed before requesting assistance from Meech.

The information below shows what is required for a 971IPS bar however, the same process can be used for any of the Hyperion range of products.

Supplying the following information will ensure your claim is processed quickly when you first contact Meech:

1. Connect to a BarMaster and turn on the equipment
2. A readout will appear on screen and we will require the following information:
  - a. Bar Code Serial Number
  - b. Product Code (i.e. A924A971-(03520 = bar length))
  - c. Frequency
  - d. Balance
  - e. Feedback
  - f. Alarm %
  - g. Ion Level %
  - h. Alarm Line
3. Status of the Warning LED (i.e. not lit, strobing red, flashing red, solid red)
4. Please provide a photo of the equipment as it is installed
5. A description and a photo or video of the problem you are experiencing
6. The action you want Meech to take e.g. repair, replace, warranty etc.



# LED Status

- 1. Power LED
- 2. Warning LED
- 3. Hz Frequency LED

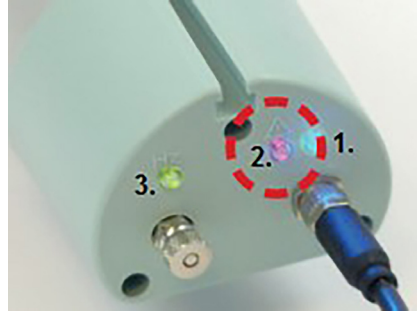

When the equipment powers on, the (1.) Blue LED will illuminate and the (3.) Hz LED will start to flash red and green in time with the Hz setting. If (2.) Warning LED starts to flash or is solid red, check the ion level with the BarMaster.

### Strobing Red



for 2 seconds indicates the BarMaster has been connected

### Flashing Red



on and off indicates more cleaning required

**Solid Red** indicates the ion level has dropped well below the alarm setting, prompting a serious fault warning. Check installation for metallic objects on the emitter pins.



Should the solid red LED persist, connect your BarMaster and follow the Troubleshooting section or contact your local Meech distributor

# Troubleshooting

| Symptoms  | Action  |
|---|---|
| Warning LED is OFF when first powered on, after a short time, if a solid red LED shows. | Connect a bar master and ensure the ion level reads 99%<br><br>If the Ion level is 0-9% the bar is faulty.<br><br>If the level is between 10-59% with a 60% alarm setting, return to the 'clean bar' section. |
| Balance drifts $\pm$  | Connect the BarMaster and switch Feedback to 'off'  |
| Distance Sensor is not changing the Hz Rate on the BarMaster                            | The Hz LED will flash red then green quicker and will show an increase on the Hz rate, however the BarMaster will not show any change.  |
| Adjustments to bar settings using BarMaster are not saved after disconnection.          | Power off BarMaster before disconnecting and reconnecting it to a second bar.   |
| BarMaster display only shows a flashing square.   | Bar is faulty and a replacement required.   |
| BarMaster has nothing in the display.   | Check power supply.   |

## Warning

Do not reset the Ion Reference without cleaning the ionising bar first. Resetting the Ion Reference with a low or 0% reading will provide a green LED, but will only mask any problem with the system.

The 971IPS requires a grounded 24V DC supply & earth stud. The 0V line must be connected to ground. Failure to do so, will result in damage to the bar or the 24V supply and will void the warranty.

# Repairs And Warranty

The Meech 971IPS-15 Bar is warranted by Meech Static Eliminators Ltd. to the original purchaser against defects in material and workmanship for two years after shipment. Should any malfunction occur, please return the bar directly to Meech Static Eliminators Ltd. or your local Meech Distributor.

The 971IPS-15 requires a grounded 24V DC supply. The 0V line **must** be connected to ground. Failure to do so, will result in damage to the bar or the 24V supply and will void the warranty.

All products returned to the factory **MUST** be accompanied by a return authorisation number and must be shipped prepaid. For prompt service, ship the unit to the factory with the return authorisation number shown clearly on the label. Be sure that it is well packed in a sturdy carton with shock absorbing material.

Include a note stating the nature of the problem as specifically as possible, and also include instructions for returning the bar to you. We will pay one-way return shipping costs on any repairs covered under the warranty.

## CE Approval

An EC Declaration of Conformity for this product exists in respect of the Low Voltage Directive: 72/23/EEC ("LVD") & Electromagnetic Compatibility Directive: 89/336/EEC ("EMCD")



## UL Approval

Static elimination bar Hyperion 971IPS has been investigated by UL in accordance with the following standard(s): UL 60950-1 & CAN/CSA C22.2 No. 60950-1-07.



# Health and Safety

Emission of Ozone: Considerably below international standard of 0.1ppm.

## Technical and Construction

|                          |   |
|--------------------------|---|
| Dimensions (W x H)       | 63mm x 70mm   |
| Maximum Length           | 4000mm  |
| Operating Range          | 300mm – 900mm   |
| Weight                   | 1.2kg/metre   |
| Construction             | ABS Plastic FR  |
| Mounting                 | 'T' Slot with M4 x 20 studs   |
| Emitters                 | Sharp titanium pins   |
| Input Current            | Max 500mA   |
| Input Voltage            | 24V DC (21-27VDC)   |
| Output Voltage           | +/- 15kV Pulsed DC  |
| Electrical Connection    | 4 Pole M8   |
| Clean Pin Output Signal  | 24V Output resistance 10kΩ  |
| Output Frequency         | Default Setting: 1Hz<br>Adjustable with BarMaster from 1Hz to 20Hz;                       |
| Output Balance           | Default Setting: 60%:40% Pos:Neg<br>Adjustable with BarMaster from 80:20 to 20:80 Pos:Neg |
| Air-boost connection     | 6mm push-fit  |
| Air consumption          | 5 cfm per 1000mm at 1 bar   |
| Environmental Protection | IP64 as standard; IP65 upon request   |
| Max Ambient Temperature  | 60 °C   |

# Technical Drawing

|   |   |
|---|---|
| <b>Meech</b>  |   |
| 1277 FIVE WAYS DRIVE, BERRIGAM, VIC 3041  |   |
| TEL: 03 9435 1010 FAX: 03 9435 1011   |   |
| WWW.MEECH.COM.AU  |   |
| MEECH ELECTROTECHNICAL PRODUCTS (AUSTRALIA) PTY. LTD. AUSTRALIA'S LEADING MANUFACTURER OF INDUSTRIAL AND COMMERCIAL ELECTRICAL CONTROL EQUIPMENT. |   |
| TITLE:  | A971PS TSMV   |
| DRAWING NO.:  | A971PS 15   |
| MATERIAL:   | Various   |
| FINISH:   | Various   |
| TOLERANCE CLASS:  | UNLESS OTHERWISE SPECIFIED, ALL DIMENSIONS ARE TO ISO 2768 MS |
| MECHANICAL DESIGN:  | CHECKED BY: [Signature]                                       |
| ELECTRICAL DESIGN:  | CHECKED BY: [Signature]                                       |
| DRAWING DATE:   | 30/03/2018  |
| DATE:   | 30/03/2018  |
| DESIGNED BY:  | Daniel Hyok   |
| DRAWN BY:   | [Signature]   |
| REVISION:   | [Signature]   |
| SHEET:  | 1 / 1   |
| STATUS:   | Production  |
| SKIGNED OFF:  | [Signature]   |

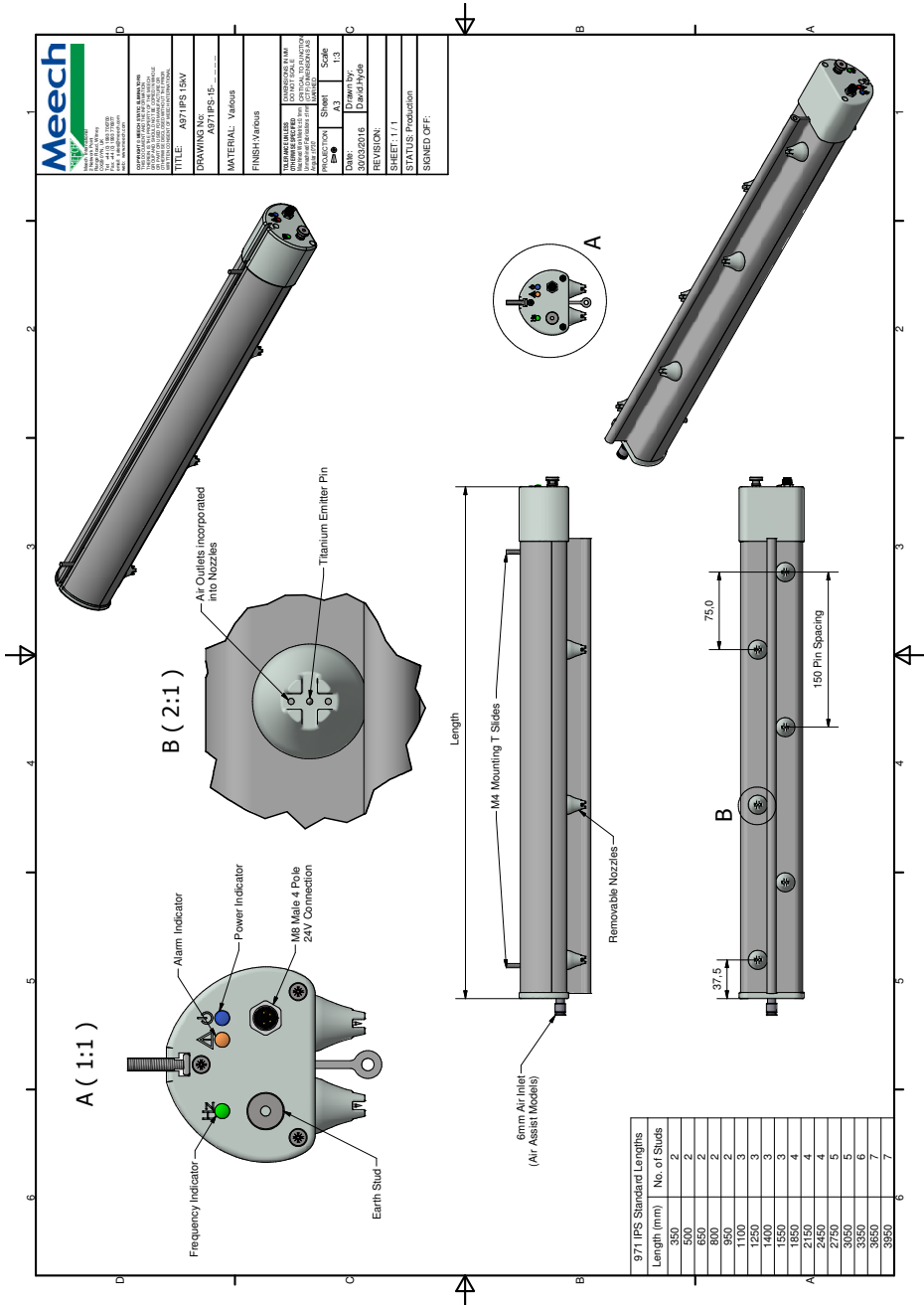

| 971 IPS Standard Lengths | Length (mm) | No. of Slides |
|--------------------------|-------------|---------------|
|                          | 500         | 2             |
|                          | 600         | 2             |
|                          | 650         | 2             |
|                          | 800         | 2             |
|                          | 850         | 2             |
|                          | 950         | 2             |
|                          | 1100        | 3             |
|                          | 1250        | 3             |
|                          | 1400        | 3             |
|                          | 1550        | 3             |
|                          | 1850        | 4             |
|                          | 2150        | 4             |
|                          | 2450        | 4             |
|                          | 2750        | 5             |
|                          | 3050        | 5             |
|                          | 3350        | 6             |
|                          | 3650        | 6             |
|                          | 3950        | 7             |









**Meech International**

2 Network Point  
Range Road, Witney  
OX29 0YN, UK

Tel: +44 (0)1993 706700  
Fax: +44 (0)1993 776977  
email: sales@meech.com

**Meech Static Eliminators  
(Shanghai) Co. Ltd**

7G, 7F, LP Tower  
#25 Xiangfeng Road  
201103 Shanghai  
China

Tel: +86 400 820 0102  
Fax: +86 21 6405 7736  
email: china@meech.com

**Meech Static Eliminators USA Inc**

2915 Newport Drive  
Norton, OH 44203  
USA

Tel: +1 330 564 2000 / 1 800 232 4210  
Fax: +1 330 564 2005  
email: info@meech.com

**Meech Shavotech**

29/2, Kharadi  
Off Pune-Nagar Road  
On Old Kharadi Mundhwa Road  
Pune : 411014 , Maharashtra  
India

Tel: +91 (0)703 093 8211 / +91 (0)741 000 4817  
Fax: +91 (080) 28395963  
email: india@meech.com

**Meech Elektrostatik SA**

Kaiserbaracke 166  
B-4780 St.Vith  
Belgium

Tel.: +49 (0)6555 3733 399  
+32 (0)80 670 204  
Fax: +32 (0)80 862 821  
email: mesa@meech.com

**Meech International  
(Singapore) Pte. Ltd.**

7 Temasek Boulevard  
12 - 07 Suntec Tower One  
Singapore  
Singapore  
038987

Tel: +65 65918859  
email: singapore@meech.com

**Meech CE**

Gábor László utca 2  
Budapest 1041  
Hungary

Tel: +36 1 7977039  
+36 30 2803334  
email: ce@meech.com