



Operating Manual

Model 977CM

Pulsed DC Controller

Contents

Introduction	3
Inspection	5
Contents	5
Option	5
Features	6
Display	6
Controls	7
Connections	7
Installation	8
Operation	10
Getting Started	10
Setting the Start Voltage and Ion Output Set Point	10
Setting the Rate	12
Setting the Balance	13
Setting the Alarm Point	14
Locking and Unlocking the Controls	15
Changing the System Set Up	16
Remote On/Off	17
Feedback	18
Feedback Setup	19
Feedback Alarm	20
Maintenance	21
Repairs And Warranty	21
CE Approval	22
Specification	22
977CM Case and Mounting Detail	23

Introduction



The Model 977CM Pulsed DC controller is designed to power Meech Industrial Pulsed DC ionisers, including:

- 971 Ionising Bar
- 261 Ionising Nozzle
- 261 Ionising Flexi-Nozzle

The unit is mains powered with an in-built switchmode power supply to allow its use on all mains voltages and frequencies. Display is via a LCD panel with adjustment made by 4 push buttons.

The Pulsed DC output has a maximum voltage of +/- 15 kV and a frequency range of 1 to 20 Hz. Output balance is adjustable from 80%/20% positive/ negative to 20% / 80% positive/negative.

In-built current monitoring maintains optimum ion output by adjusting the output voltage to counteract the effects of dirt build-up on attached ionising bars and/or nozzles.

Audible visual and remote alarms alert operators to the need to clean the ionisers. Analogue outputs enable logging of system performance.

A software lock allows the front panel controls to be locked to prevent unauthorised adjustment of the ionising system.

An input for a Meech 988 Feedback sensor bar facilitates closed-loop feedback control of the system, together with outputs for data logging etc.

Inspection

The Model 977CM Pulsed DC controller was carefully packed at our factory in a container designed to protect it from accidental damage. Nevertheless, we recommend careful examination of the carton and contents for any damage. If damage is evident, do not destroy the carton or packing material and immediately notify the carrier of a possible damage claim. Shipping claims must be made by the consignee to the delivering carrier. In addition, please also notify Meech International of any damage claims that may be made against the delivery carrier.

Contents

The following are included with the 977CM:

1. Instruction manual



2. IEC cable



3. Remote ON/OFF jack plug



Option

1. Interface cable - mini DIN



Features

Display

In normal operation* the LCD display will look similar to the following:

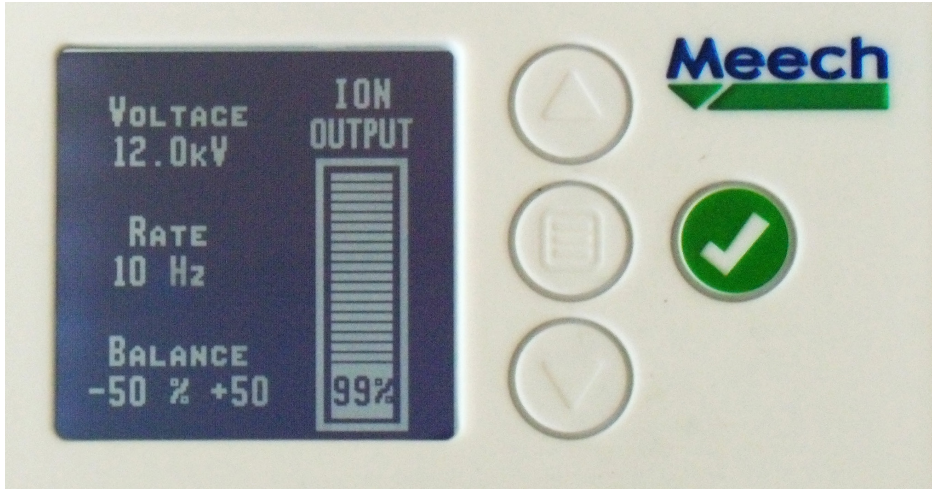

The information displayed is:

1. Power: Peak momentary output voltage in kV. This value is controlled automatically and will increase and decrease as the system maintains maximum performance.
2. Rate: Frequency of the output in Hz. The output frequency is operator set according to the type of installation and the ionising equipment connected to the 977CM.
3. Balance: Balance of the Positive and Negative outputs in Percent. The balance can be biased to positive or negative to give the most accurate neutralisation.
4. Ion Output: Graphical display of system performance with percentage value.

*Without Feedback sensor bar connected. See Feedback section on page 18 for further information.

Controls

Four buttons control the 977CM:



Up: Moves the cursor up and increases numerical values



Menu: Enters and exits the main system menu



Down: Moves the cursor down and decreases numerical values



Tick: Accepts and stores the displayed value.

Connections

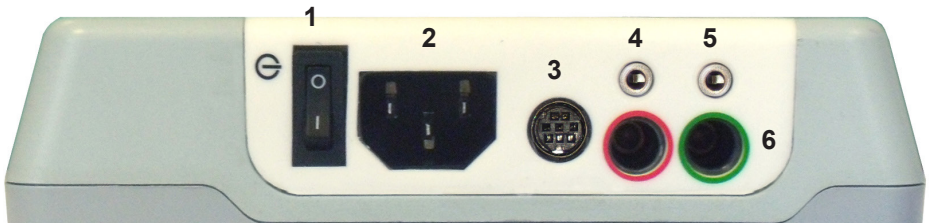

1. Mains On/Off Switch
2. Mains Inlet Socket. IEC-C13
3. Output Signals. 8 Way Mini DIN
4. Remote On/Off. 3.5mm Jack Socket
5. Feedback Sensor Bar inlet. 2.5mm Jack Socket
6. Positive and Negative HT Outputs.

Installation

Installation and connection should be completed by a qualified electrical engineer

This equipment must be grounded /earthed via the mains cable. Failure to do so can result in damage to the unit.

Locate the 977CM in a dry, well ventilated area. Allow sufficient space for the cables on the right hand side of the unit.

Mount the unit using the 5mm keyhole mounts on the rear face.



Connect ionising equipment using grey HT connections.



Connect IEC mains cable. Input voltages from 100 to 240V, 50 or 60Hz are acceptable.



Operation

Getting Started

On first use, the 977CM needs to be configured to suit the type of installation and the type of ionising equipment connected to it. This includes basic settings of the Output Power, Rate and Balance as well as alarm functionality and the lock option.

Setting the Start Voltage and Ion Output Set Point

During installation and commissioning two parameters must be set correctly to allow optimum performance.

1. Start Voltage. The correct start voltage must be set, depending on the ioniser connected to the 977CM. The correct start voltages for Meech ionisers are:





971	15 kV
242	10 kV
251	8 kV
261	7.2 kV
271/272/273	7 kV

2. Ion Output Set Point: This is the target Ion Output as measured when the system is clean. The 977CM self adjusts to try to maintain the output at this level.

- **This value should only be set when the ionisers have been cleaned, otherwise the performance of the system will be reduced**

During use, ionisers become contaminated which reduces their performance. The 977CM counteracts this by increasing the output voltage to maintain a consistent performance. The output voltage will automatically be raised up to a maximum of 125% of the pre-set start voltage.

To set the Start Voltage and Ion Output Set Point

1. Press  to enter menu
2. Press  to enter option 1 "Power"
3. Use  and  to set voltage to required voltage.
4. Press  to accept value. The unit will display "Set Ion Output"

Selecting "**Yes**" and pressing  will store the Ion Output Set Point.
Selecting "**No**" will exit setup and leave the set point unchanged.

Setting the Rate

The 977CM features a variable output frequency. The frequency that should be set depends on the ionising product and the distance to the target object.





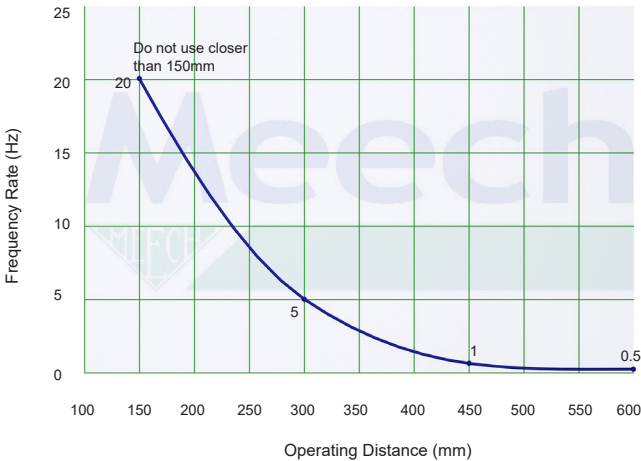

Ionising Bars: For best operation at long distance a slow rate should be set. Conversely at short range, select a fast rate. An approximate guide is as follows:

Suggested Frequency Vs Operating Distance for 971/977CM



Ionising Nozzles: Ionising Nozzles and Air Guns (251,261,271) should be used from 10 to 20 Hz.

To set the rate

1. Press  to enter menu
2. Use  and  to select option 2 "Rate"
3. Use  and  to set the required value.
4. Press  to accept value.

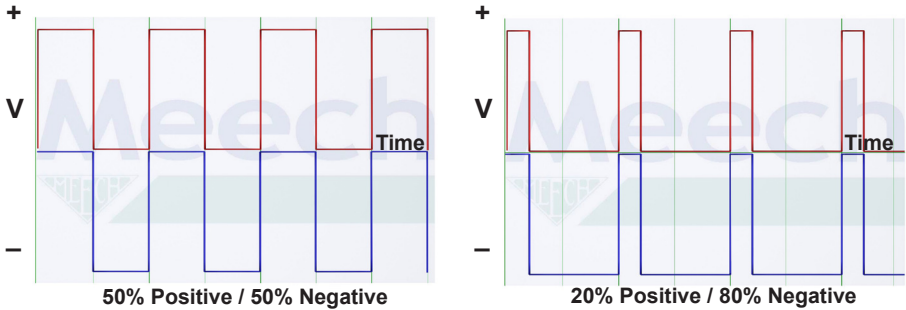

Setting the Balance

The output of the 977CM can be biased to negative or positive. The adjustment changes the percentage of time that each HT output is switched on. The maximum bias is 80% to either positive or negative.



Changing the balance of the output changes the relative amount of positive and negative ions produced by the ioniser. With the help of a static locator the balance can be adjusted for more accurate neutralisation of the target material.

To set the balance:

1. Press  to enter menu
2. Select option 3 "Balance" and press 
3. Use the up and down button to change the value
4. Press  to store the setting

Setting the Alarm Point



The 977CM features an adjustable alarm that will alert the operator when the Ion Output of the ionising system falls below a desired level or when a system fault is detected.

As the ionisers become contaminated, the 977CM increases the output voltage to maintain maximum Ion Output. When the maximum voltage has been reached and the ionisers become further contaminated, the Ion Output will slowly start to decrease and will reduce the system's performance. At this point the ionisers need cleaning.

To alert the operator to the need for cleaning, the 977CM will trigger an in-built audible alarm and the LCD screen will flash on and off. A remote alarm can also be triggered using the alarm relay connections on the output socket.

The alarm point is set as a percentage of maximum Ion Output. An initial value of 60% is recommended.

To set the Alarm Point.

1. Press  to enter menu
2. Select option 4 "Alarm" and press 
3. Use the up and down button to change the value
4. Press  to store the setting





Locking and Unlocking the Controls

The front panel controls of the 977CM can be locked to prevent unauthorised adjustment of the ionising system. The lock code is a user selected three digit code. A different code can be chosen each time the unit is locked.

The performance of the ionising system depends on being run at the correct power, rate and balance. Unauthorised or accidental changes to any of these settings can greatly reduce its effectiveness.





To lock the controls:

Select a three digit lock code. Keep this number safe as you will need it to unlock the unit at a later date.

5. Press  to enter menu
6. Select option 5 “Lock” and press 
7. Use the up and down button to change the value of the first digit.
8. Press  to move to the next digit and set its value.
9. Finally, press  to lock the controls.

Note that when locked a Padlock icon will appear at the top of the screen.

To unlock the controls:

1. Press  to enter menu.
2. Select option 5 “Unlock” and press 
3. Use the up, down and  buttons to enter the three digit code.
4. Press  to unlock the controls.

- If the three digit code is forgotten or lost, contact your local Meech office or your Meech distributor to get the Master Unlock Code.

Changing the System Set Up







The Set Up option allows the setting of the Feedback gain and controls the operation of the in-built audible alarm.

The 977CM allows the use of an external Feedback sensor bar to monitor the accuracy of the system's static neutralisation. When a Meech 988 Feedback bar is connected to the 977CM a bar chart on the LCD display shows the residual balance of static charge on the material after passing the ionising bar. The feedback gain adjusts the sensitivity of the bar graph. The setting is from 1 to 10. An increase of 1 represents a doubling of sensitivity of the bar graph.

See the section on Feedback on page 18 for full details of how to use the Feedback system.

The In-built audible alarm can be enabled or disabled to suit the installation.

To set the Feedback gain and audible Alarm operation

1. Press  to enter menu.
2. Select option 6 "Setup" using the down button and press .
3. Set the desired gain level using the Up and Down buttons and store the value by pressing .
4. The screen will now display "Buzzer Enabled" .
5. Select "**Yes**" or "**No**" using the  or  button and press  to store the setting.

Input/Output Connections

Remote On/Off

The output of the 977CM can be turned on and off remotely via the socket located on the connection panel.

A 3.5mm Jack plug connected to volt-free contacts will allow the 977CM to be switched on when the contacts are made.

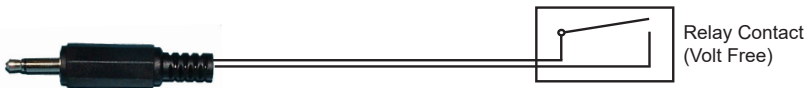

Output Signals



The 8 Way Mini DIN connector offers the following outputs:

Offset: When the system is used in feed back mode with a model 988 feedback sensor bar connected, the offset output mimics the bargraph on the LCD display. 0 Volts equates to a sufficiently large negative voltage being detected to give full scale deflection to negative. 2.5 Volts equates to no voltage being detected. 5V equates to a positive voltage large enough to give full scale deflection to positive.

Ion Output: 0-5V mimics the Ion output bargraph on the LCD display. 5V=100%

Alarm: The alarm relay changes state when the system detects an alarm condition, including low ion output.

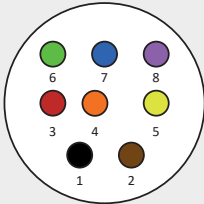
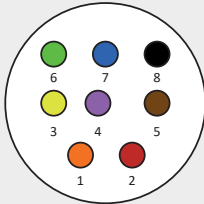
A prewired, 2 or 5 metre, output cable is available upon request. Please, contact Meech representative for details. Cable connections are as follows:

	Function	2 Metre Cable	5 Metre Extension Cable
Terminal 1	Ground (0V)	Black	Orange
Terminal 2	Offset 0-5V	Brown	Red
Terminal 3	Not Used	Red	Yellow
Terminal 4	12V (200mA max)	Orange	Purple
Terminal 5	Ion Output 0-5V	Yellow	Brown
Terminal 6	Alarm Relay NC	Green	Green
Terminal 7	Alarm Relay COM	Blue	Blue
Terminal 8	Alarm Relay NO	Purple	Black
Diagram	Male Plug		
Item Code		A900-DATA-CAB-2M	A900-DATA-CAB-5M
Drawing			

Feedback

The addition of a Meech 988 Feedback sensor bar can greatly increase the accuracy of the neutralisation of static charges. By providing closed-loop control of the 977CM the residual static charges on materials can be minimised despite changing conditions and machine running speeds. This is particularly useful on rewinds, where large charges can build up if the ionising system is not adjusted correctly. The feedback system is primarily intended for use on installations using Meech model 971 Pulsed DC Ionising bars.

In normal operation, the 977CM operates at a fixed rate and balance. The frequency is set dependent on the distance from the ionising bar to the target material. Using a static locator (983v2) the charge on the material after it has passed the ionising bar can be measured. Ideally, the Ion balance of the output can be adjusted by the operator, to remove all the charge on the material.

In reality, changes in running conditions, materials and cleanliness of the bar means that this ideal state cannot be reached without constant adjustment of the pulsed DC controller.

The implementation of a feedback sensor bar allows this measurement and adjustment to happen continuously. This results in the most accurate neutralisation possible, regardless of changing conditions.

The positioning of the sensor bar is critical. It must be located such that it detects the voltage on the material only and is not influenced directly by the Model 971 Pulsed DC Ionising bar. Your Meech engineer will be able to advise you on this. General examples of positioning follow.

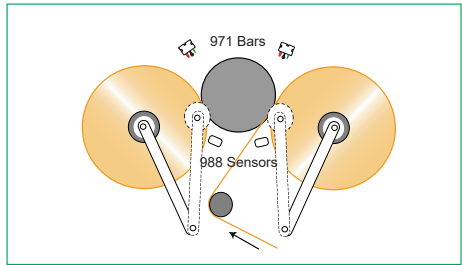
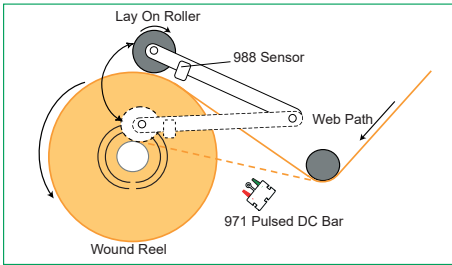

Feedback Setup

1. Switch off the 977CM and connect the feedback sensor bar using the 2.5mm jack plug.
2. Switch on the 977CM. The LCD display will now display an additional bargraph that represents the voltage being detected by the sensor bar.

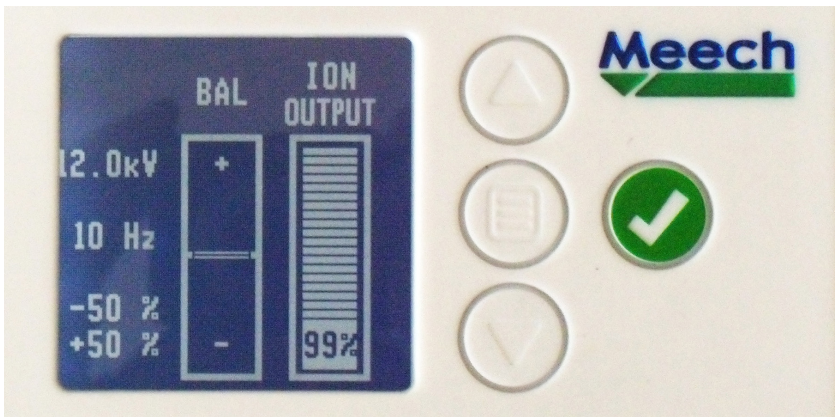

3. Use the front panel controls to set the correct output voltage (page 9) and the rate (page 11).
4. The 977CM will now continuously adjust the balance of the output to attain the most accurate neutralisation of charge possible.

Feedback Alarm

The feedback system features an alarm that indicates when the system is not neutralising charge within preset limits. The alarm is triggered when the bargraph reaches full scale either positive or negative.

The sensitivity of the alarm points can be reduced or increased by altering the Feedback Gain (page 15). Setting a high gain value will increase the sensitivity of the system and trigger the alarm at relatively low voltage on the material.

The use of a model 983V2 static locator allows the selection of an appropriate Feedback Gain setting. Comparing actual readings of voltage on the material with the bargraph will provide an approximate calibration of the system.

When an alarm condition is met, the alarm relay will change state and the internal buzzer will sound. To alert the operator that the static levels have exceeded the desired maximum, the alarm state is maintained until the system is reset.

Maintenance

The only maintenance required is that the exterior of the 977CM Pulsed DC Controller should be cleaned regularly with a dry cloth to keep it free from dust and other contaminants.



Repairs & Warranty

The 977CM Pulsed DC Controller is warranted by Meech Static Eliminators Ltd to the original purchaser against defects in material and workmanship for one year after purchase. Should any malfunction occur, please return the unit directly to Meech Static Eliminators or your local distributor. All products returned to the factory MUST be accompanied by a return authorisation number and must be shipped prepaid. For prompt service, ship the unit to the factory with the return authorisation number shown clearly on the label. Be sure it is well packed in a sturdy carton with shock absorbing material.

Include a note stating the nature of the problem as specifically as possible, and also include instructions for returning the unit to you. We will pay one-way return surface shipping costs on any repairs covered under the warranty.

Field repairs should never be undertaken. Attempts by unqualified personnel to repair the unit will invalidate the warranty.

CE Approval

An EC declaration of conformity for this product exists in respect of the Low Voltage Directive: 72/23/EEC (“LVD”) & Electromagnetic Compatibility Directive: 89/336/EEC (“EMCD”)



Specification

Input connection	IEC Socket C13
Input voltage	100 V - 250 V AC
Input current	40 mA maximum
Input frequency	45 - 65 Hz
Dimensions (W x H x D)	190mm x 170mm x 45mm
Weight	600g
Enclosure	ABS
Maximum temperature (LCD)	45° C
Output voltage	up to 15kV
Output frequency	1Hz - 20Hz
Output balance	20/80 to 80/20 Positive/Negative

977CM Case & Mounting Detail

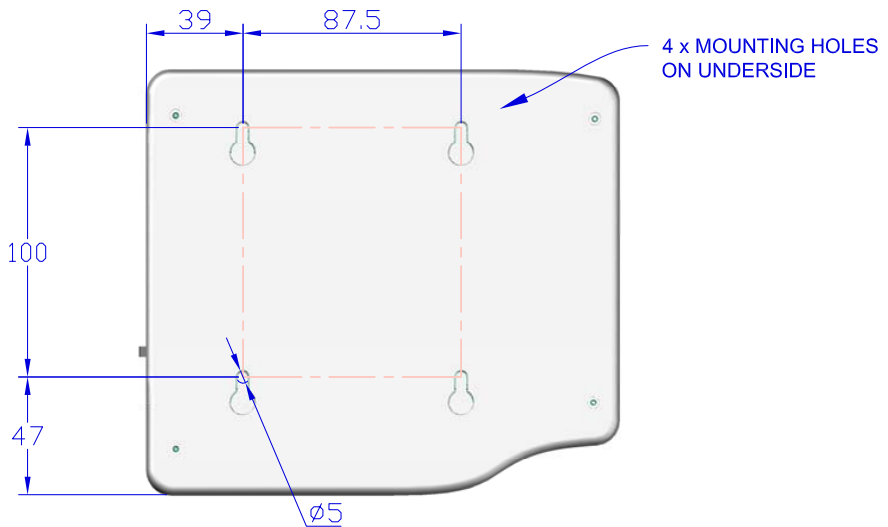
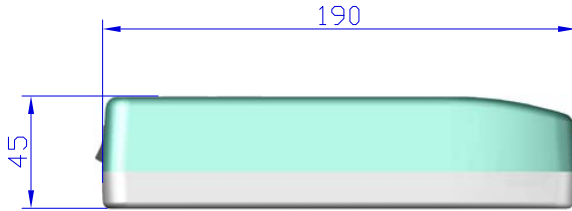



Meech International

2 Network Point
Range Road, Witney
OX29 0YN, UK

Tel: +44 (0)1993 706700
Fax: +44 (0)1993 776977
email: sales@meech.com

Meech Static Eliminators (Shanghai) Co. Ltd

7G, 7F, LP Tower
#25 Xiangfeng Road
201103 Shanghai
China

Tel: +86 400 820 0102
Fax: +86 21 6405 7736
email: china@meech.com

Meech Static Eliminators USA Inc

2915 Newport Drive
Norton, OH 44203
USA

Tel: +1 330 564 2000 / 1 800 232 4210
Fax: +1 330 564 2005
email: info@meech.com

Meech Shavotech

29/2, Kharadi
Off Pune-Nagar Road
On Old Kharadi Mundhwa Road
Pune - 411014 , Maharashtra
India

Tel: +91 (0)703 093 8211 / +91 (0)741 000 4817
Fax: +91 (080) 28395963
email: india@meech.com

Meech Elektrostatik SA

Kaiserbaracke 166
B-4780 St.Vith
Belgium

Tel.: +49 (0)6555 3733 399
+32 (0)80 670 204
Fax: +32 (0)80 862 821
email: mesa@meech.com

Meech International (Singapore) Pte. Ltd.

7 Temasek Boulevard
12 - 07 Suntec Tower One
Singapore
Singapore
038987

Tel: +65 65918859
email: singapore@meech.com

Meech CE

Gábor László utca 2
Budapest 1041
Hungary

Tel: +36 1 7977039
+36 30 2803334
email: ce@meech.com